

UP Squared

Maker Board
UPS-APL

User's Manual 5th Ed

Copyright Notice

This document is copyrighted, 2020. All rights are reserved. The original manufacturer reserves the right to make improvements to the products described in this manual at any time without notice.

No part of this manual may be reproduced, copied, translated, or transmitted in any form or by any means without the prior written permission of the original manufacturer. Information provided in this manual is intended to be accurate and reliable. However, the original manufacturer assumes no responsibility for its use, or for any infringements upon the rights of third parties that may result from its use.

The material in this document is for product information only and is subject to change without notice. While reasonable efforts have been made in the preparation of this document to assure its accuracy, AAEMON assumes no liabilities resulting from errors or omissions in this document, or from the use of the information contained herein.

AAEMON reserves the right to make changes in the product design without notice to its users.

Acknowledgement

All other products' name or trademarks are properties of their respective owners.

- Microsoft®, Windows® are registered trademarks of Microsoft Corp.
- Intel®, Pentium®, and Celeron® are registered trademarks of Intel Corporation
- Intel Atom™ is a trademark of Intel Corporation
- ITE is a trademark of Integrated Technology Express, Inc.

All other product names or trademarks are properties of their respective owners.

Packing List

Before setting up your product, please make sure the following items have been shipped:

Item	Quantity
● UPS-APL (UP Squared Board)	1

If any of these items are missing or damaged, please contact your distributor or sales representative immediately.

About this Document

This User's Manual contains all the essential information, such as detailed descriptions and explanations on the product's hardware and software features (if any), its specifications, dimensions, jumper/connector settings/definitions, and driver installation instructions (if any), to facilitate users in setting up their product.

Users may refer to the product page at AAEON.com for the latest version of this document.

Safety Precautions

Please read the following safety instructions carefully. It is advised that you keep this manual for future references

1. All cautions and warnings on the device should be noted.
2. Make sure the power source matches the power rating of the device.
3. Position the power cord so that people cannot step on it. Do not place anything over the power cord.
4. Always completely disconnect the power before working on the system's hardware.
5. No connections should be made when the system is powered as a sudden rush of power may damage sensitive electronic components.
6. If the device is not to be used for a long time, disconnect it from the power supply to avoid damage by transient over-voltage.
7. Always disconnect this device from any AC supply before cleaning.
8. While cleaning, use a damp cloth instead of liquid or spray detergents.
9. Make sure the device is installed near a power outlet and is easily accessible.
10. Keep this device away from humidity.
11. Place the device on a solid surface during installation to prevent falls
12. Do not cover the openings on the device to ensure optimal heat dissipation.
13. Watch out for high temperatures when the system is running.
14. Do not touch the heat sink or heat spreader when the system is running
15. Never pour any liquid into the openings. This could cause fire or electric shock.
16. As most electronic components are sensitive to static electrical charge, be sure to ground yourself to prevent static charge when installing the internal components. Use a grounding wrist strap and contain all electronic components in any static-shielded containers.

17. If any of the following situations arises, please the contact our service personnel:
 - i. Damaged power cord or plug
 - ii. Liquid intrusion to the device
 - iii. Exposure to moisture
 - iv. Device is not working as expected or in a manner as described in this manual
 - v. The device is dropped or damaged
 - vi. Any obvious signs of damage displayed on the device

18. **DO NOT LEAVE THIS DEVICE IN AN UNCONTROLLED ENVIRONMENT WITH TEMPERATURES BEYOND THE DEVICE'S PERMITTED STORAGE TEMPERATURES (SEE CHAPTER 1) TO PREVENT DAMAGE.**

Warning!



This device complies with Part 15 FCC Rules. Operation is subject to the following two conditions: (1) this device may not cause harmful interference, and (2) this device must accept any interference received including interference that may cause undesired operation.

Caution:

There is a danger of explosion if the battery is incorrectly replaced. Replace only with the same or equivalent type recommended by the manufacturer. Dispose of used batteries according to the manufacturer's instructions and your local government's recycling or disposal directives.

Attention:

Il y a un risque d'explosion si la batterie est remplacée de façon incorrecte. Ne la remplacer qu'avec le même modèle ou équivalent recommandé par le constructeur. Recycler les batteries usées en accord avec les instructions du fabricant et les directives gouvernementales de recyclage.

China RoHS Requirements (CN)

产品中有毒有害物质或元素名称及含量

AAEON Main Board/ Daughter Board/ Backplane

部件名称	有毒有害物质或元素					
	铅 (Pb)	汞 (Hg)	镉 (Cd)	六价铬 (Cr(VI))	多溴联苯 (PBB)	多溴二苯醚 (PBDE)
印刷电路板 及其电子组件	○	○	○	○	○	○
外部信号 连接器及线材	○	○	○	○	○	○

O: 表示该有毒有害物质在该部件所有均质材料中的含量均在 SJ/T 11363-2006 标准规定的限量要求以下。

X: 表示该有毒有害物质至少在该部件的某一均质材料中的含量超出 SJ/T 11363-2006 标准规定的限量要求。

备注: 此产品所标示之环保使用期限, 系指在一般正常使用状况下。

China RoHS Requirement (EN)

Poisonous or Hazardous Substances or Elements in Products

AAEON Main Board/ Daughter Board/ Backplane

Component	Poisonous or Hazardous Substances or Elements					
	Lead (Pb)	Mercury (Hg)	Cadmium (Cd)	Hexavalent Chromium (Cr(VI))	Polybrominated Biphenyls (PBB)	Polybrominated Diphenyl Ethers (PBDE)
PCB & Other Components	○	○	○	○	○	○
Wires & Connectors for External Connections	○	○	○	○	○	○
<p>O: The quantity of poisonous or hazardous substances or elements found in each of the component's parts is below the SJ/T 11363-2006-stipulated requirement.</p> <p>X: The quantity of poisonous or hazardous substances or elements found in at least one of the component's parts is beyond the SJ/T 11363-2006-stipulated requirement.</p> <p>Note: The Environment Friendly Use Period as labeled on this product is applicable under normal usage only</p>						

Table of Contents

Chapter 1 - Product Specifications	1
1.1 Specifications	2
Chapter 2 – Hardware Information	4
2.1 Dimensions	5
2.2 Jumpers and Connectors.....	7
2.3 List of Jumpers and Connectors.....	9
2.3.1 RTC Battery (CN1)	10
2.3.2 Power Button (CN2)	10
2.3.3 Reset (CN3)	11
2.3.4 Camera 4-Lane (CN4)	11
2.3.5 Camera 2-Lane (CN5).....	12
2.3.6 eDP (CN6)	12
2.3.7 M.2 E-KEY (CN7)	13
2.3.8 Mini Card (CN8)	14
2.3.9 SATA (CN9)	15
2.3.10 SATA (CN10)	16
2.3.11 USB 3.0 OTG (CN13)	16
2.3.12 USB 3.0 DUAL PORT (CN14).....	16
2.3.13 USB 3.0 (CN15)	17
2.3.14 USB Panel (CN16).....	17
2.3.15 FAN (CN17).....	18
2.3.16 LAN Dual Port (CN18).....	18
2.3.17 HAT 40 (CN20)	19
2.3.18 EXHAT (CN21).....	21
2.3.19 CPLD and BIOS update (CN22)	22
2.3.20 CPLD and BIOS update (CN22)	23

2.3.21	HDMI Dual Port (CN24).....	23
Chapter 3	– Drivers Installation.....	25
3.1	Driver Download and Installation.....	26
Appendix A	– UP Framework SDK Installation.....	27
A.1	Introduction.....	28
A.2	Installation for Windows 10.....	28
A.3	Installation for Windows IoT Core.....	31
Appendix B	– Cables and Connectors.....	33
B.1	Cables and Connectors.....	34

Chapter 1

Product Specifications

1.1 Specifications

System

Processor	Intel® processor SoC formerly Apollo Lake Intel® Pentium® N4200 Intel® Celeron® N3350 Intel® Atom™ E3940/ E3950
CPU Frequency	Intel® Celeron™ N3350 Processor, 2M Cache, 1.10 GHz up to 2.40 GHz Intel® Pentium™ N4200 Processor, 2M Cache, 1.10 GHz up to 2.50 GHz Intel® Atom™ E3940 Processor, 2M Cache, 1.60 GHz up to 1.80 GHz Intel® Atom™ E3950 Processor, 2M Cache, 1.60 GHz up to 2.00 GHz
Graphics	Intel® Gen 9 HD, supporting 4K Codec Decode and Encode for HEVC4, H.264, VP8
I/O	HDMI x 1 DP x 1 I2S Audio Port
Camera	CSI 2-Lane + CSI 4-Lane
USB	USB 2.0 x 2 USB 3.0 OTG x 1 USB 3.0 (Type A) x 3
Expansion	40 pin GPIO x 1 Mini-PCIe x 1 M.2 2230 x 1 SATA3 x 1 60 pin EXHAT x 1

System

RTC	Yes
Power	5V DC-in at 4A ~ 6A
Dimension	3.37" x 3.54" (85.6 mm x 90 mm)
Memory	2GB (single channel) LPDDR4 4GB/8GB (dual channel) LPDDR4
Storage	eMMC 32/ 64/ 128 GB
Display Interface	eDP
Ethernet	Gigabit Ethernet RJ-45 x 2
OS Support	Microsoft Windows 10, Windows IOT Core Linux (ubinux, Ubuntu, Yocto) Android Nougat
Operating Temperature	32°F ~ 140°F (0°C ~ 60°C)
Operation Humidity	0% ~ 90% relative humidity, non-condensing
Certification	CE/FCC Class A, RoHS Compliant, REACH

Chapter 2

Hardware Information

2.1 Dimensions

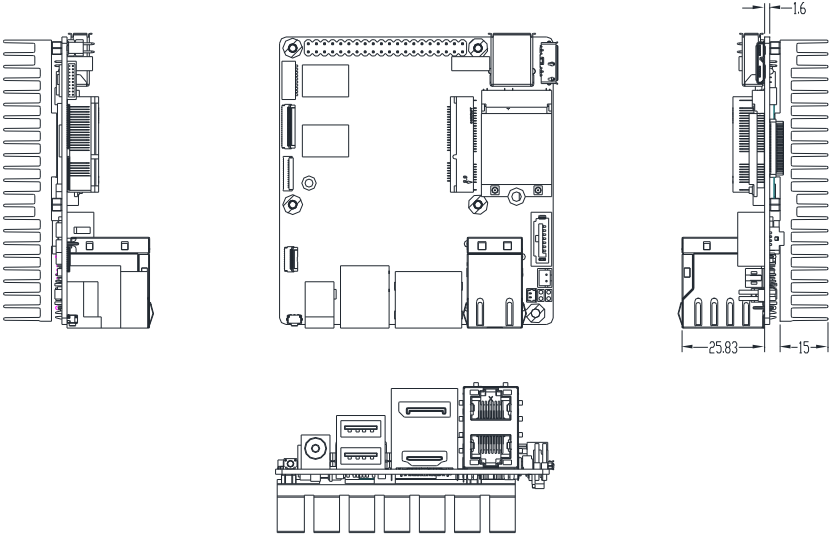

With Heatsink

Maker Board

UPS-APL

UP Squared

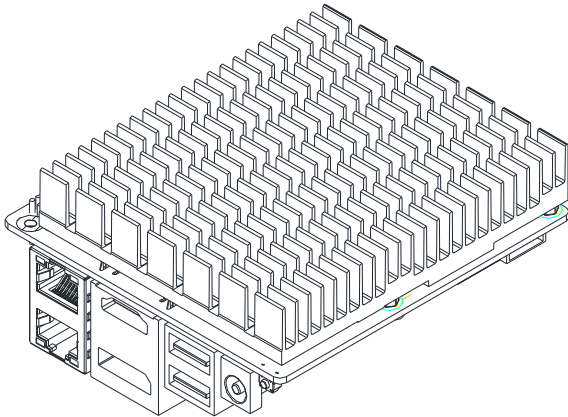
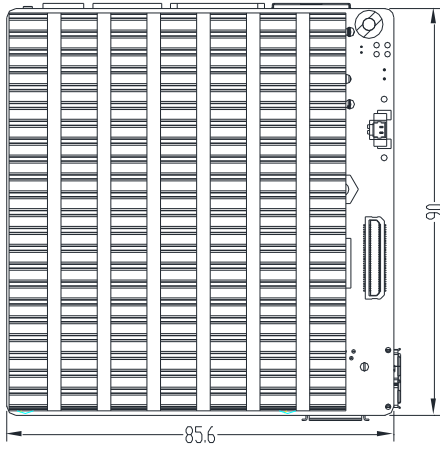

2.2 Jumpers and Connectors

Top:

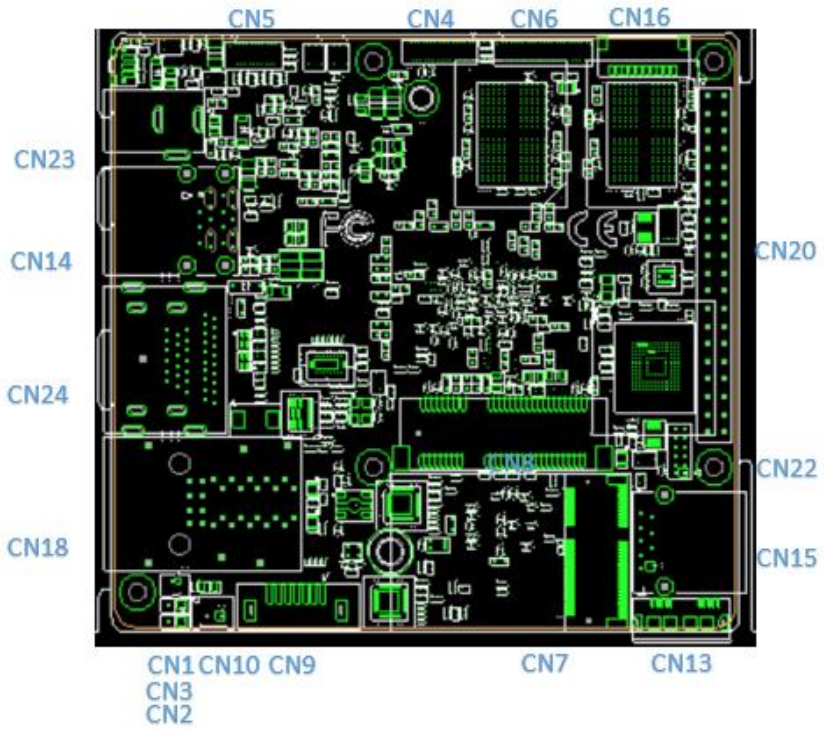

Bottom:

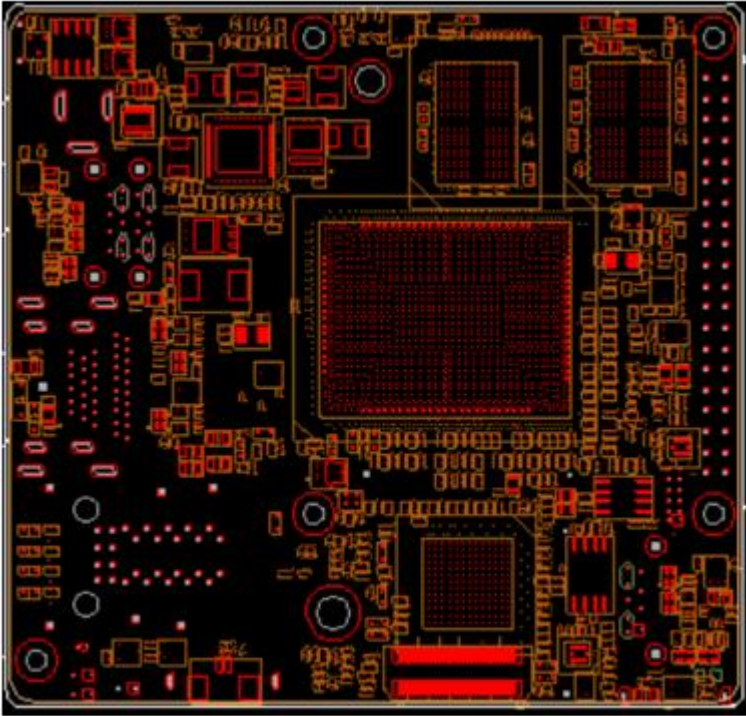

CN17

CN21

2.3 List of Jumpers and Connectors

Please refer to the table below for all of the board's jumpers that you can configure for your application

Label	Function
CN1	RTC
CN2	Power Button
CN3	Reset
CN4	Camera 4-Lane
CN5	Camera 2-Lane
CN6	eDP
CN7	M.2 E-Key
CN8	Mini Card
CN9	SATA
CN10	SATA Power
CN13	USB3.0 OTG
CN14	USB3.0 Dual Port
CN15	USB3.0
CN16	USB Panel
CN17	FAN
CN18	LAN Dual Port
CN20	HAT40
CN21	EXHAT
CN22	CPLD and BIOS Update
CN23	DC Jack
CN24	HDMI + DP Port

2.3.1 RTC Battery (CN1)

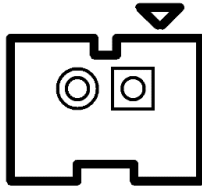

Pin	Signal
1	3.3V
2	GND

Note: Vbat RTC only accessible from CN1.

2.3.2 Power Button (CN2)

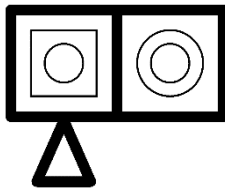

Pin	Signal
1	PWRBTN #
2	GND

2.3.3 Reset (CN3)

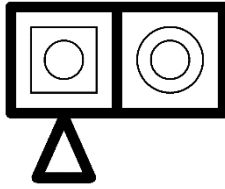

Pin	Signal
1	RESET #
2	GND

2.3.4 Camera 4-Lane (CN4)

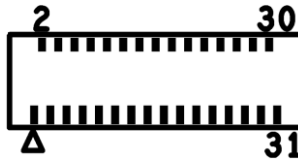

Pin	Signal	Pin	Signal	Pin	Signal
1	GND	2	RESET #	3	NC
4	I2C_DAT	5	I2C_CLK	6	GND
7	CLOCK	8	GND	9	data negative 0
10	data positive 0	11	GND	12	data negative 1
13	data positive 1	14	GND	15	clock negative
16	clock positive	17	GND	18	data negative 2
19	data positive 2	20	GND	21	data negative 3
22	data positive 3	23	GND	24	2.8V
25	GND	26	1.2V	27	1.8V
28	GND	29	2.8V	30	2.8V
31	GND	32		33	

2.3.5 Camera 2-Lane (CN5)

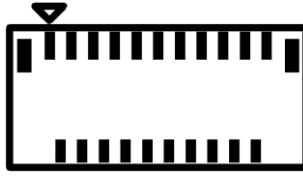

Pin	Signal	Pin	Signal	Pin	Signal
1	GND	2	data negative 1	3	data positive 1
4	GND	5	clock negative	6	clock positive
7	GND	8	data negative 0	9	data positive 0
10	GND	11	1.2V	12	1.8V
13	GND	14	CLOCK	15	GND
16	I2C_CLK	17	I2C_DAT	18	RESET #
19	RESET #	20	2.8V	21	GND

2.3.6 eDP (CN6)

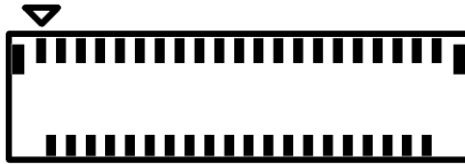

Pin	Signal	Pin	Signal	Pin	Signal
1	NC	2	NC	3	GND
4	NC	5	NC	6	GND
7	NC	8	NC	9	GND
10	NC	11	NC	12	GND
13	NC	14	NC	15	GND
16	data positive 0	17	data negative 0	18	GND
19	data positive 1	20	data negative 1	21	GND

Pin	Signal	Pin	Signal	Pin	Signal
22	data positive 2	23	data negative 2	24	GND
25	data positive 3	26	data negative 3	27	GND
28	AUX positive	29	AUX negative	30	GND
31	Hot Plug Detect	32	Back Light Control	33	VDD Enable
34	Back Light Enable	35	I2C_CLK	36	I2C_DAT
37	3.3V	38	3.3V	39	3.3V
40	3.3V	41	3.3V		

2.3.7 M.2 E-KEY (CN7)

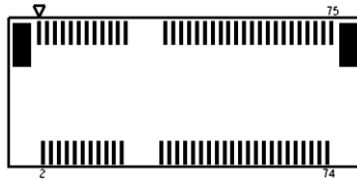

Pin	Signal	Pin	Signal	Pin	Signal
1	GND	2	3.3V	3	USB_D+
4	3.3V	5	USB_D-	6	NC
7	GND	8	NC	9	NC
10	NC	11	NC	12	NC
13	NC	14	NC	15	NC
16	NC	17	NC	18	GND
19	NC	20	NC	21	NC
22	UART_RXD	23	NC	24	N/A
25	N/A	26	N/A	27	N/A
28	N/A	29	N/A	30	N/A
31	N/A	32	UART0_TXD	33	GND
34	UART0_CTS	35	PCIE_C_TXP3	36	UART0_RTS
37	PCIE_C_TXN3	38	NC	39	GND

Pin	Signal	Pin	Signal	Pin	Signal
40	NC	41	PCIE_RXP3	42	NC
43	PCIE_RXN3	44	NC	45	GND
46	NC	47	CLK_PCIE_M2_P	48	NC
49	CLK_PCIE_M2_N	50	Suspend Clock	51	GND
52	RESET #	53	PCIE_M2_CLKREQ#	54	Bluetooth Enable
55	WAKE #	56	Wi-Fi Enable	57	GND
58	SMBus_DAT	59	NC	60	SMBus_CLK
61	NC	62	SMBus_Alert	63	GND
64	NC	65	NC	66	NC
67	NC	68	NC	69	GND
70	NC	71	NC	72	3.3V
73	NC	74	3.3V	75	GND

2.3.8 Mini Card (CN8)

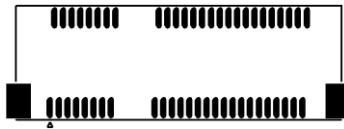

Pin	Signal	Pin	Signal
1	WAKE #	2	3.3V
3	NC	4	GND
5	INT_SERIRQ	6	1.5V
7	PCIE_MINI_CLKREQ#	8	NC
9	GND	10	NC
11	CLK_PCIE_MINI_N	12	NC
13	CLK_PCIE_MINI_P	14	NC
15	GND	16	NC
17	NC	18	GND

Pin	Signal	Pin	Signal
19	NC	20	3G Enable
21	GND	22	RESET #
23	PERn0_mSATA_R+	24	3.3V
25	PERp0_mSATA_R-	26	GND
27	GND	28	1.5V
29	GND	30	I2C_CLK
31	PETn0_mSATA_T-	32	I2C_DAT
33	PETp0_mSATA_T+	34	GND
35	GND	36	USB_D-
37	GND	38	USB_D+
39	3.3V	40	GND
41	3.3V	42	NC
43	mSATA_PCl_e_SEL_C	44	NC
45	NC	46	NC
47	NC	48	1.5V
49	NC	50	GND
51	NC	52	3.3V

2.3.9 SATA (CN9)



Pin	Signal	Pin	Signal	Pin	Signal
1	GND	2	TX+	3	TX-
4	GND	5	RX-	6	RX+
7	GND	8		9	

2.3.10 SATA (CN10)

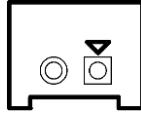

Pin	Signal
1	5V/2A
2	GND

2.3.11 USB 3.0 OTG (CN13)

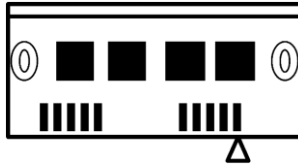

Pin	Signal	Pin	Signal	Pin	Signal
1	5V	2	USB2_D-	3	USB2_D+
4	ID	5	GND	6	USB3_RX-
7	RSB3_RX+	8	GND	9	USB3_TX-
10	USB3_TX+	11		12	

2.3.12 USB 3.0 DUAL PORT (CN14)

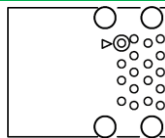

Pin	Signal	Pin	Signal	Pin	Signal
1	5V	2	USB2_D1-	3	USB2_D1+
4	GND	5	USB3_RX1-	6	USB3_RX1+
7	GND	8	USB3_TX1-	9	USB3_TX1+

Pin	Signal	Pin	Signal	Pin	Signal
10	5V	11	USB2_D2-	12	USB2_D2+
13	GND	14	USB3_RX2-	15	USB3_RX2+
16	GND	17	USB3_TX2-	18	USB3_TX2+

2.3.13 USB 3.0 (CN15)

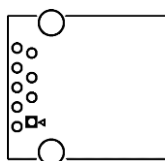

Pin	Signal	Pin	Signal	Pin	Signal
1	5V	2	USB2_D-	3	USB2_D+
4	GND	5	USB3_RX-	6	USB3_RX+
7	GND	8	USB3_TX-	9	USB3_TX+

2.3.14 USB Panel (CN16)

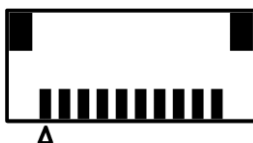

Pin	Signal	Pin	Signal
1	5V	2	USB2_D1-
3	USB2_D1+	4	GND
5	5V	6	USB2_D2-
7	USB2_D2+	8	GND
9	UART_RX (3V3 TTL)	10	UART_TX (3V3 TTL)

2.3.15 FAN (CN17)

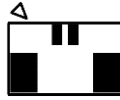

Pin	Signal	Pin	Signal
1	5V	2	GND

2.3.16 LAN Dual Port (CN18)

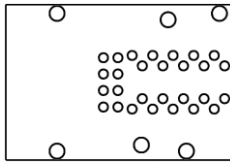

Pin	Signal	Pin	Signal
R1A	LAN1_MDIO+	R2A	LAN1_MDIO-
R3A	LAN1_MDIO1+	R4A	LAN1_MDIO1-
R5A	LAN1_MDIO2+	R6A	LAN1_MDIO2-
R7A	LAN1_MDIO3+	R8A	LAN1_MDIO3-
R9A	GND	R10A	GND
L1A	LAN1_ACTLED-	L2A	LAN1_ACTLED+
L3A	LAN1_LINK1000#	L4A	LAN1_LINK100#
R1B	LAN2_MDIO+	R2B	LAN2_MDIO-
R3B	LAN2_MDIO1+	R4B	LAN2_MDIO1-
R5B	LAN2_MDIO2+	R6B	LAN2_MDIO2-
R7B	LAN2_MDIO3+	R8B	LAN2_MDIO3-
R9B	GND	R10B	GND
L1B	LAN2_ACTLED-	L2B	LAN2_ACTLED+
L3B	LAN2_LINK1000#	L4B	LAN2_LINK100#

2.3.17 HAT 40 (CN20)

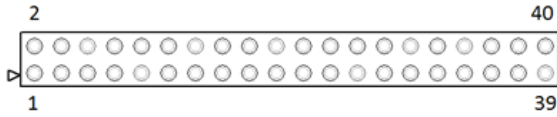

Pin	Signal	BIOS
1	3V3/1A	
2	5V/1A	
3	GPIO0/I2C1_SDA	GPIO1
4	5V/1A	
5	GPIO1/I2C1_SCL	GPIO2
6	GND	
7	GPIO2/ADC_in1	GPIO3
8	GPIO15/UART_TXD	GPIO16
9	GND	
10	GPIO16/UART_RXD	GPIO17
11	GPIO3/UART_RTS/ADC_in2	GPIO4
12	GPIO17/I2S_BCLK	GPIO18
13	GPIO4/ADC_in3	GPIO5
14	GND	
15	GPIO5/ADC_in4	GPIO6
16	GPIO18	GPIO19
17	3V3/1A	
18	GPIO19	GPIO20
19	GPIO6/SPI_1_TXD	GPIO7
20	GND	
21	GPIO7/SPI_1_RXD	GPIO8
22	GPIO20	GPIO21
23	GPIO8/SPI_1_CLK	GPIO9

Pin	Signal	BIOS
24	GPIO21/SPI_1_FS0	GPIO22
25	GND	
26	GPIO22/SPI_1_FS1	GPIO23
27	GPIO9/I2C0_SDA	GPIO10
28	GPIO23/I2C0_SCL	GPIO24
29	GPIO10	GPIO11
30	GND	
31	GPIO11	GPIO12
32	GPIO24/PWM0	GPIO25
33	GPIO12/PWM1	GPIO13
34	GND	
35	GPIO13/I2S_WS_SYNC	GPIO14
36	GPIO25/UART_CTS	GPIO26
37	GPIO14	GPIO15
38	GPIO26/I2S_SDI	GPIO27
39	GND	
40	GPIO27/I2S_SDO	GPIO28

Note: All GPIO pins are 3V3.

2.3.18 EXHAT (CN21)

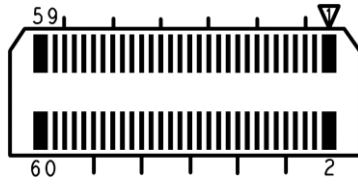

Pin	Signal	Pin	Signal
1	GPIO1	2	GPIO2
3	GPIO3	4	GPIO4
5	GND	6	GND
7	GPIO5	8	GPIO6
9	GPIO7	10	GPIO8
11	GND	12	GND
13	GPIO9	14	GPIO10
15	GPIO11	16	GPIO12
17	GND	18	GND
19	GPIO13	20	GPIO14
21	GPIO15	22	GPIO16
23	GND	24	GND
25	PLL_IN-	26	PLL1_OUT-
27	PLL1_IN+	28	PLL1_OUT+
29	GND	30	GND
31	INT_SERIRQ_R	32	LPC_R_CLKOUT0
33	LPC_CLKRU_N	34	GND
35	GND	36	LPC_R_AD3
37	SIO_SPI_1_TXD	38	LPC_R_AD2
39	SIO_SPI_1_RXD	40	LPC_R_AD1
41	SIO_SPI_1_FS0	42	LPC_R_AD0

Pin	Signal	Pin	Signal
43	SIO_SPI1_FS1	44	GND
45	SIO_SPI1_CLK	46	LPC_FRAME_R
47	GND	48	GND
49	I2C_SCL3_3V3	50	AVS_DMIC_CLK_A1
51	I2C_SDA3_3V3	52	AVS_DMIC_CLK_B1
53	GND	54	AVS_DMIC_CLK_AB2
55	I2C_SCL2_3V3	56	GND
57	I2C_SDA2_3V3	58	AVS_DMIC_DATA_1
59	GND	60	AVS_DMIC_DATA_2

2.3.19 CPLD and BIOS update (CN22)

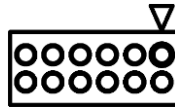

Pin	Signal	Pin	Signal	Pin	Signal
1	JTAG_TCK	2	GND	3	JTAG_TDO
4	1.8V	5	JTAG_TMS	6	SPI_CS
7	SPI_CLK	8	SPI_MISO	9	JTAG_TDI
10	GND	11	SPI_MOSI	12	SPI_HOLD

2.3.20 CPLD and BIOS update (CN22)

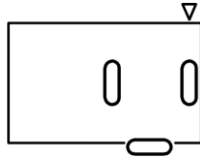

Pin	Signal	Pin	Signal	Pin	Signal
1	5V	2	GND	3	GND

2.3.21 HDMI Dual Port (CN24)

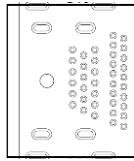

Pin	Signal	Pin	Signal
P1	DDIO_TXP_DP_0	P2	GND
P3	DDIO_TXN_DP_0	P4	DDIO_TXP_DP_1
P5	GND	P6	DDIO_TXN_DP_1
P7	DDIO_TXP_DP_2	P8	GND
P9	DDIO_TXN_DP_2	P10	PORT0_CLK+
P11	GND	P12	PORT0_CLK-
P13	CONFIG1	P14	CONFIG2
P15	DP_AUX_P	P16	GND
P17	DP_AUX_N	P18	DDIO_TYPE_C_HPD
P19	GND	P20	3.3V
P21	DDI1_TXP_HDMI_0	P22	GND
P23	DDI1_TXN_HDMI_0	P24	DDI1_TXP_HDMI_1
P25	GND	P26	DDI1_TXN_HDMI_1

Pin	Signal	Pin	Signal
P27	DDI1_TXP_HDMI_2	P28	GND
P29	DDI1_TXN_HDMI_2	P30	DDI1_CLK+_HDMI
P31	GND	P32	DDI1_CLK-_HDMI
P33	HDMI1_CEC_D	P34	NC
P35	DDC_CLK	P36	DDC_DATA
P37	GND	P38	5V
DDI1_TYPE_C_HPD			

Chapter 3

Drivers Installation

3.1 Driver Download and Installation

Please access <https://www.up-community.org> and go to the Downloads section > UP Squared to find the relevant drivers.

Appendix A

UP Framework SDK Installation

A.1 Introduction

This section provides instructions for the installation of the UP Framework SDK. Instructions are provided for Windows 10 and Windows IoT Core. You can download the latest version of UP Framework SDK from the UP community:

<https://downloads.up-community.org/download/up-sdk-for-windows-10-and-windows-iot/>

A.2 Installation for Windows 10

Step 1

Locate the downloaded file UpFrameworkSetup.msi and run the installer. Press “Next” to begin the setup process.

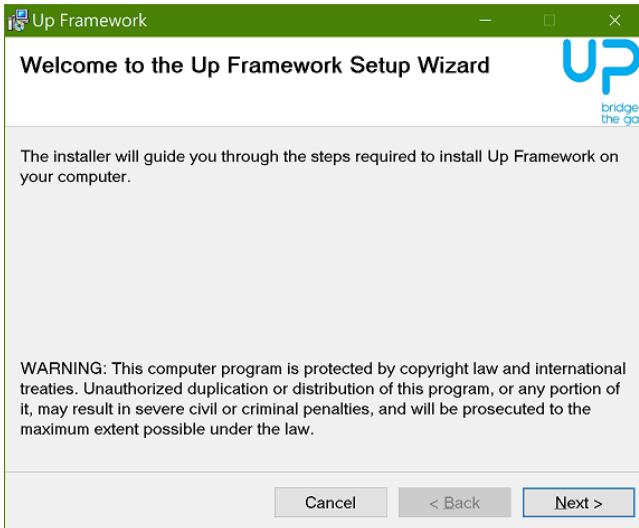

Step 2

Select the installation folder. Default destination path is C:\Program Files(x86)\AAEON\
 You may also choose to install the UP Framework SDK for all users or only the current user. Press "Next" to continue installation.

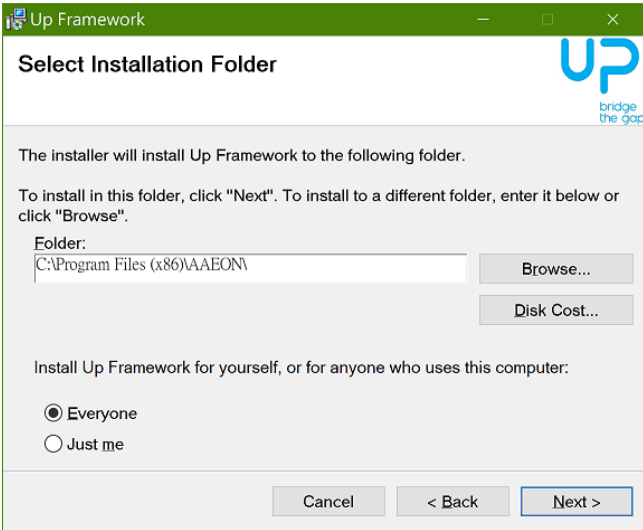

Step 3

Press "Next" to confirm the installation.

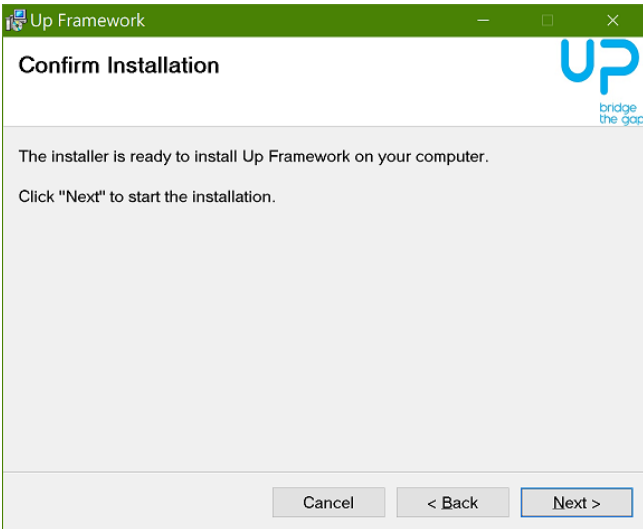

Step 4

Press "Close" to exit once setup is complete.

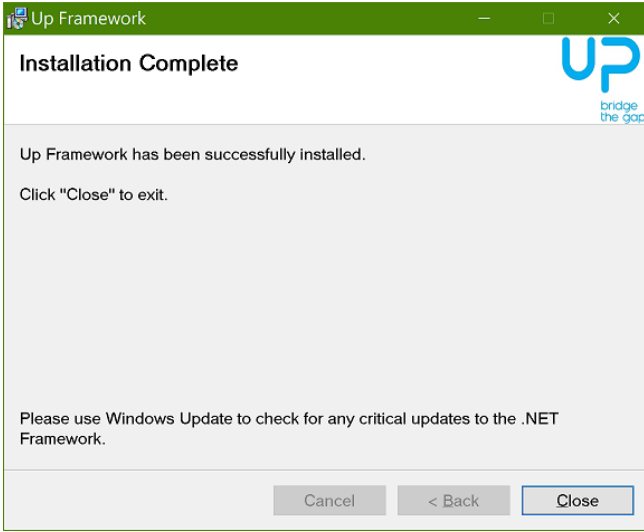

A.3 Installation for Windows IoT Core

Before you begin, make sure you have downloaded and installed the latest version of the Windows IoT Core image from the UP community.

Installation requires using a connected PC with the UP Framework SDK software downloaded and saved. **Note:** Make sure the UP IoT Core device is connected to the same network as the PC you are using to install the software from.

Step 1

Turn on your UP IoT Core device and note the IP address at the home screen.

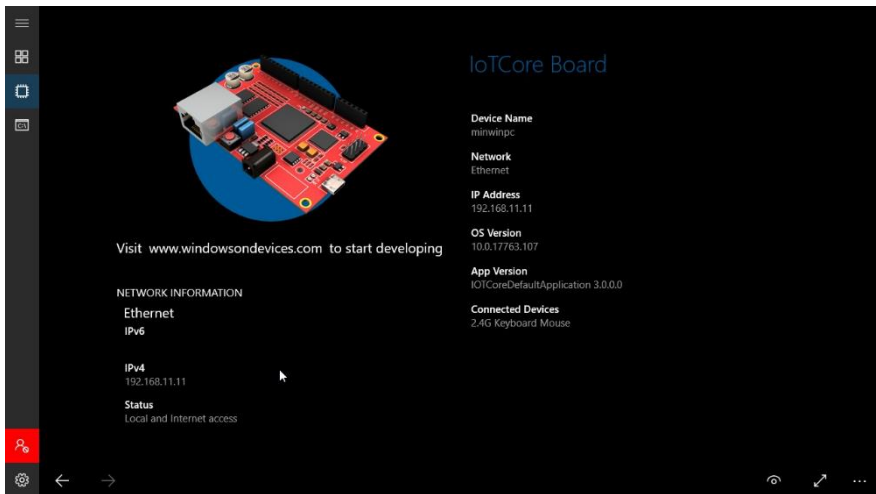

Step 2

Download the UP Framework SDK to your PC and unzip the files.

Open PowerShell as an Administrator. Run the command

`RemoteInstallation.ps1` to install the UP Framework SDK.

Enter the IP address of the UP IoT Core device when prompted.

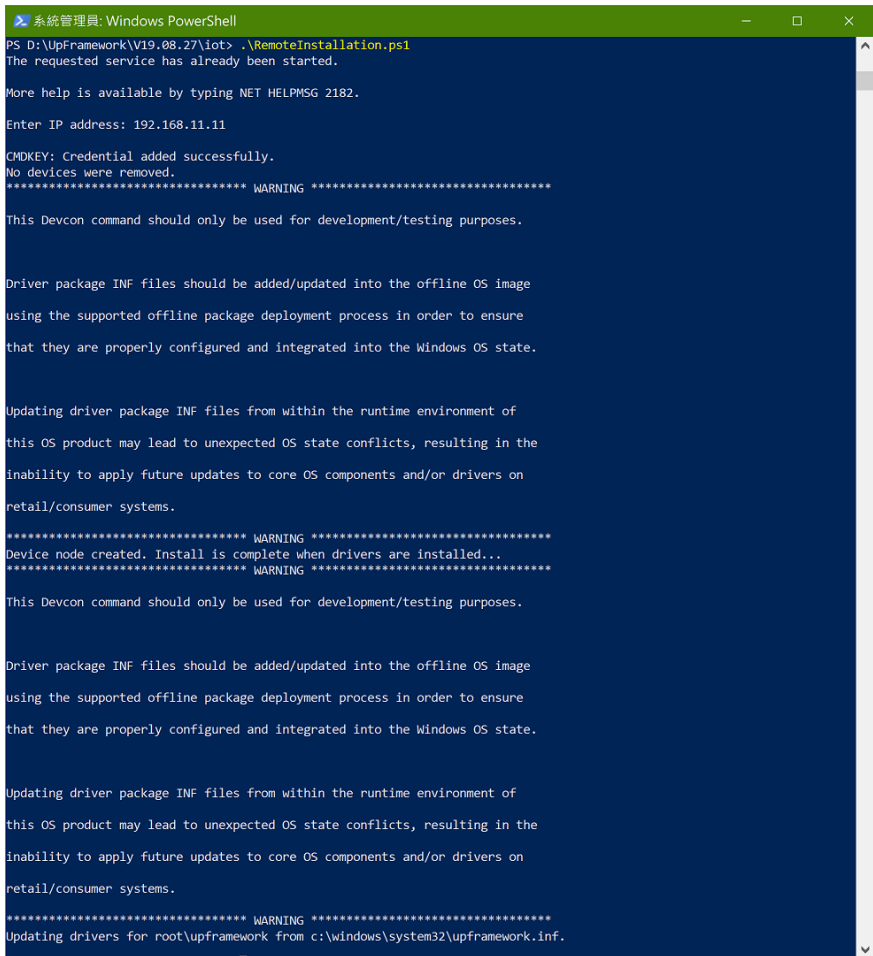

```
系統管理員: Windows PowerShell
PS D:\UpFramework\19.08.27\iot> .\RemoteInstallation.ps1
The requested service has already been started.

More help is available by typing NET HELPMSG 2182.

Enter IP address: 192.168.11.11

CMDKEY: Credential added successfully.
No devices were removed.
***** WARNING *****
This Devcon command should only be used for development/testing purposes.

Driver package INF files should be added/updated into the offline OS image
using the supported offline package deployment process in order to ensure
that they are properly configured and integrated into the Windows OS state.

Updating driver package INF files from within the runtime environment of
this OS product may lead to unexpected OS state conflicts, resulting in the
inability to apply future updates to core OS components and/or drivers on
retail/consumer systems.

***** WARNING *****
Device node created. Install is complete when drivers are installed...
***** WARNING *****
This Devcon command should only be used for development/testing purposes.

Driver package INF files should be added/updated into the offline OS image
using the supported offline package deployment process in order to ensure
that they are properly configured and integrated into the Windows OS state.

Updating driver package INF files from within the runtime environment of
this OS product may lead to unexpected OS state conflicts, resulting in the
inability to apply future updates to core OS components and/or drivers on
retail/consumer systems.

***** WARNING *****
Updating drivers for root\upframework from c:\windows\system32\upframework.inf.
```

Appendix B

Cables and Connectors

B.1 Cables and Connectors

This table provides detailed information about the cables and connectors used by the UP Squared (UPS-APL). If you have any questions about the configuration of your board, please contact your AAEON sales representative.

Label	Connector PN	Description	Mating Cable PN	Mating Cable Description
CN1	1655902034	RTC Battery Connector	175011301K	Lithium Battery.CR2032H.3V.240mAH. w/cable 90mm. DIPBattery power.BP-CR2032-M90-001
CN2	165300210C	Power Button	N/A	
CN3	165300210C	System Reset	N/A	
CN4	1654903130	MIPI 31-pin connector	N/A	
CN5	1654902130	MIPI 21-pin connector	N/A	
CN6	1654904130	eDP Connector	N/A	
CN7	1654207533	m.2 2230 E Key	N/A	
CN8	1654226303	mini-PCIe (PCIe x1)	N/A	
CN9	1654907009	SATA 9P	N/A	
CN10	1655302025	SATA Power (DC 5V)	N/A	
CN13	1654801033	Micro USB3.0 Type B	N/A	
CN14	1654818301	Dual USB3.0 Type A	N/A	
CN15	1654809302	Sigle USB3.0 Type A	N/A	
CN16	1655810131	USB2.0+UART connector	N/A	Housing JST PH1.0 1*10P
CN17	1655802020	2-pin Fan connector	N/A	
CN18	1440210AT0	GbE RJ-45	N/A	
CN20	165302020L	40-pin HAT Connector	1703401301	(TF)WIRE.16Pto 40Pin.130mm.Housing.for FWAA-1218

Label	Connector PN	Description	Mating Cable PN	Mating Cable Description
CN21	1654006000	60-pin EXHAT connector	N/A	
CN23	1652503109	5V DC Jack	N/A	
CN24	1654403931	HDMI 2.0 + DP 1.2	N/A	
SW1	1601000990	Power Button	N/A	