

Wi-Fi 6 Antenna

Revise5

RFA-27-C55-U-B70-1

Specifications

Frequency	2400-2500MHz	5150-5900 MHz	6000-7125 MHz
Peak gain	2.62 dBi	4.2 dBi	4.1 dBi
Average gain	1.02 dBi	2.24 dBi	1.6 dBi
VSWR	2.0 : 1 Max.	2.5 : 1 Max.	3.0 : 1 Max.
Polarization	Linear, vertical		
Impedance	50 Ω		
Connector	RP SMA PLUG		

Environment & Mechanical Characteristics

Temperature	- 10°C to +55°C
Humidity	95% @ 25°C



VSWR

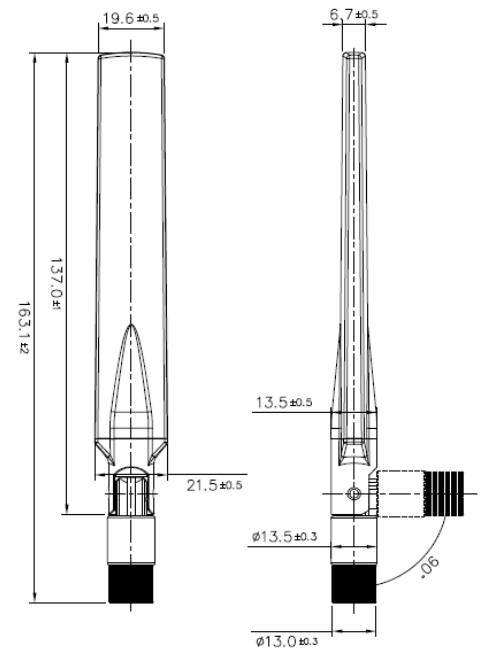
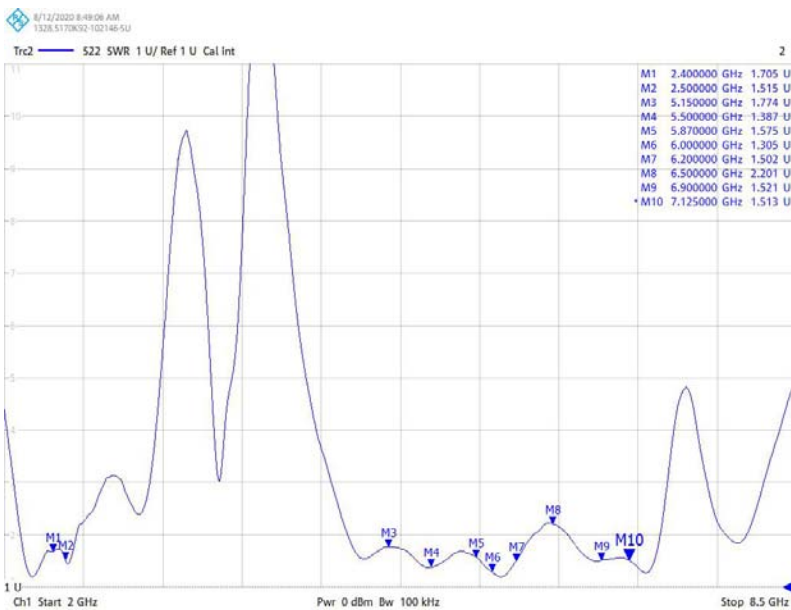

Radiation Pattern

XY

YZ

ZX

2400 MHz
2450 MHz
2500 MHz

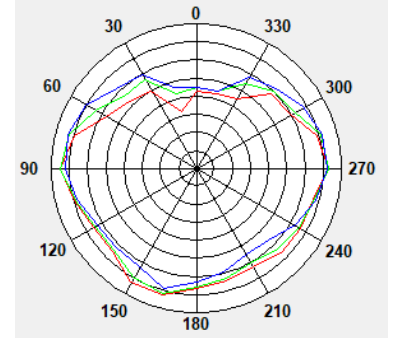
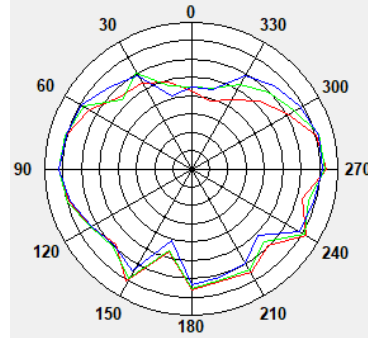
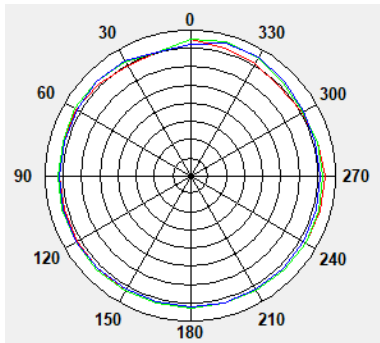

5150 MHz
5210 MHz
5290 MHz
5350 MHz
5475 MHz
5530 MHz
5600 MHz
5610 MHz
5690 MHz
5725 MHz
5750 MHz
5765 MHz
5825 MHz
5875 MHz
5975 MHz

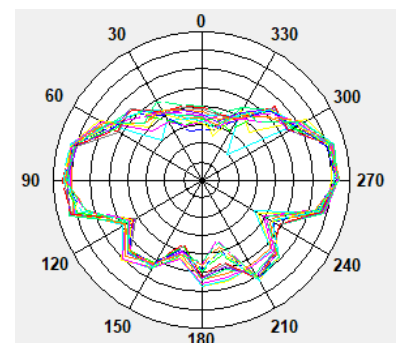
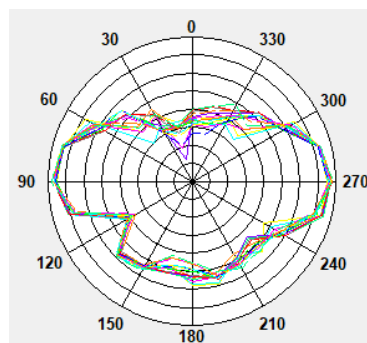
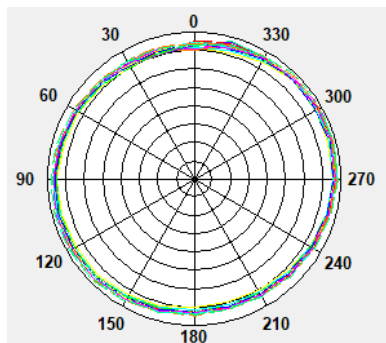

6000 MHz
6055 MHz
6135 MHz
6215 MHz
6295 MHz
6375 MHz
6455 MHz
6535 MHz
6615 MHz
6695 MHz
6775 MHz
6855 MHz
6935 MHz
7015 MHz
7075 MHz
7125 MHz

