

NO: [FJOS1808183](#)客 户: **F14AA0217**

CUSTOMER _____

承 认 书

SPECIFICATION FOR APPROVAL

客户料号: **EP-PS5V6A65WUPS**

CUSTOMER PART NO _____

福佳型号: **FJ-SW20170506000 (2017)**

FUJIA PART NO _____

品名规格: **5V 6000mA 开关电源**

DESCRIPTION _____

编制日期: **2024-08-12(C14 过六级)**

DATE

(过 Reach、过加州 65)

制造商 MANUFACTURE			客户承认 CUSOMER APPROVER
设计 DESIGN	审核 CHECKED	批准 APPROVED	请客户确认回传我司存档, 谢谢
江琪梦			

深圳市福佳电器有限公司

SHENZHEN FUJIA APPLIANCE CO., LTD.

地址: 深圳市龙华区大浪街道华宁路西恒昌荣(星辉)科技工业园 F 栋 5 楼

电话: 0755-33663999 传真: 0755- 33668366 邮编: 518109



TABLE OF CONTENTS**目录**

- 1 概述/SCOPE**
- 2 输入特性/INPUT CHARACTERISTICS**
- 3 输出特性/OUTPUT CHARACTERISTICS**
- 4 保护功能/ PROTECTION FUNCTION**
- 5 环境要求/ENVIRONMENTAL REQUIREMENTS**
- 6 机械特性 MECHANICAL CHARACTERISTICS**
- 7 安全标准 /SAFETY**
- 8.EMC 标准/ EMC STANDARD**
- 9 体积/VOLUME**
- 10 重量/WEIGHT**
- 11 外观图/OUTLOOK DRAWING**
- 12 铭牌/LABEL**
- 13 包装图示/PACKING**
- 14 样品测试报告 / SAMPLES TEST REPORT**

版本 REV.	变更内容描述 Description of Change	变更日期 Changed Date
A1	1.更新欧盟认证标准 2.更新 PE 袋子 3.更新脚垫	2021-04-20
A2	1.更改白盒标内容 2.增加安全手册及制作要求 3.去掉白盒二维码贴纸	2021-10-11
A3	更新铭牌	2024-08-12

1 概述 /SCOPE

本规格书适合于 [FJ-SW20170506000](#) 认证型号的开关电源。

The purpose of the document is to the specify the functional requirements of [FJ-SW20170506000](#)switching power supply.

2. 输入特性/ INPUT CHARACTERISTICS:

2.1 输入电压/ Input Voltage

额定输入电压/ Rated Input Voltage: 100-240Vac

可变输入电压/Variable input voltage : 90V—264Vac

2.2 输入电流/Input Current:

当输入额定电压带额定负载时，最大的输入交流电流 [1.5A](#)

[1.5A](#) max when input rated voltage and output rated load.

2.3 输入频率/ Input Frequency

额定频率/Rate Frequency:50/60Hz

调整频率/ Variation Frequency: 47-63Hz

2.4 浪涌电流/In-rush Current:

当输出为额定负载，环境温度为 25℃,输入 240Vac 冷启动时的最大浪涌电流为 60A。

60 A mps Max Cold start at 240Vac input ,with rated load and 25℃ ambient.

2.5 AC 漏电流/ AC leakage Current:

当输入电压 240Vac 时，最大的漏电流为 3.5mA

[3.5mA](#) Max .At 240Vac input

3. 输出特性/OUTPUT CHARACTERISTICS:

3.1 额定输出功率/Rated Output Power [30W](#)

3.2 负载特性/调整率 (Combined Load/line Regulation)

电压	最小负载	最大负载	满载输出电压	空载输出电压
Voltage	Min. Load	Max Load	Load Regulation	Unload output voltage
+5V	0A	6A	4.75-5.45V	4.75-5.45V

3.3 效率/Efficiency:

6 级平均工作效率 \geq [85.07%](#)

当输入 115VAC 时，平均效率 \geq [85.07%](#)。是输出额定负载的 25%,50%,75%,100%4 种情况下平均效率，

115VAC input, the average efficiency $\geq 85.07\%$. output rated load is 25%,50%,75%,100% 4 situations of average efficiency

当输入 230VAC 时, 平均效率 $\geq 85.07\%$ 。是输出额定负载的 25%,50%,75%,100%4 种情况下平均效率,

230VAC input, the average efficiency $\geq 85.07\%$. output rated load is 25%,50%,75%,100% 4 situations of average efficiency

3.3.1 VI 级 10%工作效率 $\geq 69.64\%$

当输入 115VAC/230VAC 时, 效率是 69.64% 。是输出额定负载的 10%.

115VAC/230VAC input, the efficiency is 69.64% . Is 10% of the output rated load.

3.4 空载待机功率/Unload standby Power: 0.1W Max

3.5 纹波和噪音/ Ripple And Noise

纹波与噪声: 量测时示波器选用 20MHz 带宽限制,输出端要并联一颗 0.1uF 的陶瓷电容和一颗 47uF 的电解电容. (在额定输入及输出的条件下检测)

Ripple & Noise: Measurement is done by 20MHz bandwidth oscilloscope and the output paralleled a 0.1uF ceramic capacitor and a 47uF electrolysis capacitor. (test under the condition of rated input and rated output)

电压	电流	最大纹波最大噪音
Voltage	current	Ripple And Noise(Max)
<u>+5V</u>	<u>6000mA</u>	120m Vp-p

3.6 启动延迟时间/ Turn On Delay Time:

当输入 100Vac 和输出最大负载时, 最大启动时间为 5S

5 second Max .At 100Vac input and output Max. Load

3.7 上升时间/ Rise Time:

当输入 100Vac 和输出最大负载时最大时间为 100ms

100ms Max. At 100Vac input and output Max. Load

3.8 保持时间/Hold Up Time :

当输入 100Vac 和输出最大负载时, 最小保持时间为 5ms

5ms Min.at100Vac input and output Max .Load.

3.9 过冲/ Overshoot:

在电源开启或关闭的时候, 最大 10%

10% Max. When power supply on or turn off.

4. 保护功能/ PROTECTION FUNCTION:

4.1 短路电路保护/Short circuit protection:

电源供给器在短路解除后能正常恢复工作。

The Power Supply will be auto recovered when short circuit faults remove.

4.2 过流保护/ Over current Protection:

过流点限制/Over Current Point Limited:是额定电流的 6.6-12A (input:110-230Vac)
当过电流时,输出将进入打嗝模式,当过流情况解除后,产品将会自动恢复正常

The output shall hiccup when the over currents applied to the output t rail, and shall be self-recovery when the fault condition is removed

5. 环境要求/ENVIRONMENTAL REQUIREMENTS

5.1 工作温度/Operating Temperature

0°C -- +45°C,满载, 正常工作。

0°C to +45°C ,Full Load, Normal Operation.

5.2 储存温度/Storage temperature

带外壳 :-10°C -- +55°C

With enclosure:-10°C to+55°C

5.3 工作湿度/Relative Humidity:

5%(0°C)~90%(40°C),72 小时, 满载, 正常工作。

5%(0°C)~90%(40°C) 72h Full Load , Normal operating.

5.4 振动/ Vibration:

5.4.1 测试标准: 国际电工电子委员会

Operating: IEC 721-3-3 3M3

5~9Hz,A=1.5mm

加速度 (9~200Hz,Acceleration 5m/s)

5.4.2. 运输 (Transportation) :

IEC 721-3-2 2M2

5~9Hz, A=3.5mm

9~200Hz ,加速度 Acceleration=5 m/s²

200~500Hz ,加速度 acceleration=15 m/s²

5.4.3. 轴向振动/ Axes,10 cycles per axis :

在测试过程中不能出现永久性损坏.

No permanent damage occur during testing.

在电源开启和关闭后, 样机能够恢复到最初条件。

The product has to restore to its original situation after power off/on

6. 机械特性/ MECHANICAL CHARACTERISTICS

6.1 摇摆实验/Cable Flexing Testing

DC 引线吊重 400 克, 摇摆角 45 度, 最少能承受 2000 次, 弯曲速度每分 40 次, 不会出现损伤。

The DC cord shall with weight of 400g,it swings at angle 45 deg ,2000cycle

Time min Bending speed: 40cycle per minute shall to be no breakage to the code

7. 安全标准 SAFETY STANDARD

7.1 安全:符合标准 IEC60950+62368,EN60950+62368, UL60950+62368,GB4943.1+GB8898。

Safety Accord with IEC60950+62368,EN60950+62368, UL60950+62368,GB4943.1+GB8898。

注: 相应的 AC 插脚对应相应国家的标准, 如 CE 即对应为 EN60950+62368,1500Vac。

Note :AC pins corresponsding corresponding corponding to national standards,such as the CE that corresponds to EN60950+62368 ;1500Vac。

7.2 高压/ DIELECTRIC STRENGTH Hi-Pot

初级对次级/ Primary to secondary, 1500Vac/5mA/60s.

7.3 绝缘阻抗/ Insulation resistance:

初级对次级/ Primary to secondary :10M Ω Min at 500V DC

7.4 可靠性RELIABILITY

平均无故障间隔时间MEAN TIME BETWEEN FAILURE (MTBF)

开关电源设计平均无间隔时间最小工作在50000小时以上, 满载100%, 25度环境, 正常输入电压按标准: MIL-HDBK-217F.

The power supply shall be designed and produced to have a mean time between failures (MTBF) of 50000 operating hours minimum conditions: 100% load at 25 °C, nominal input voltage.

Standard:MIL-HDBK-217F.

8. EMC 标准/EMC STANDARD

EMC---EN55032+55024

9 · 体积/VOLUME: L×W×H

长 121.8mm ×宽 54.3mm×高 33.8mm

10 · 重量/ Weight : 205g ±20g

11 外观图/OUTLOOK DRAWING (公差/Common difference: +/-0.5mm)

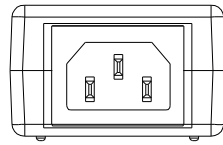
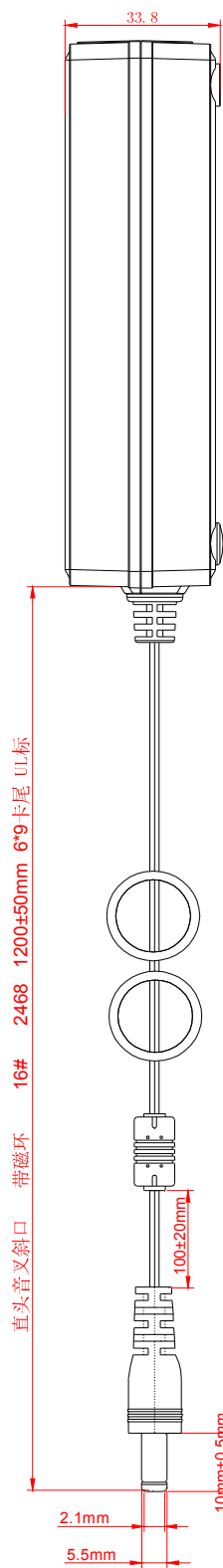

品字尾/C14

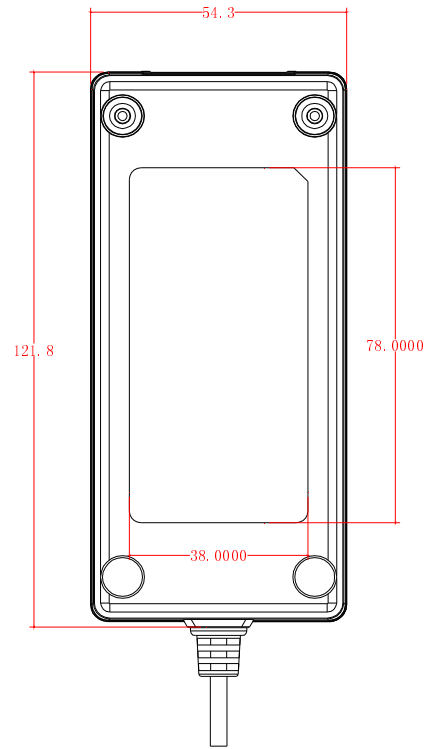

**线材/外壳/脚垫
过 REACH
过加州 65**

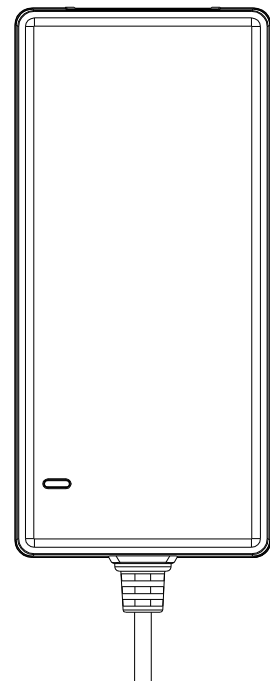

12. 铭牌/LABEL:

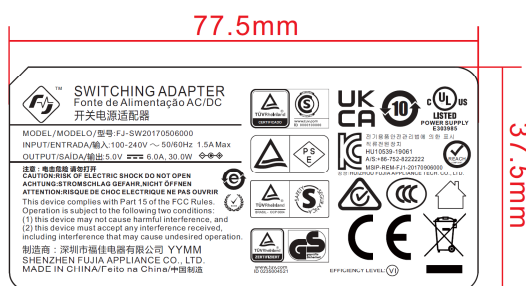

比例/Scale: 1:1

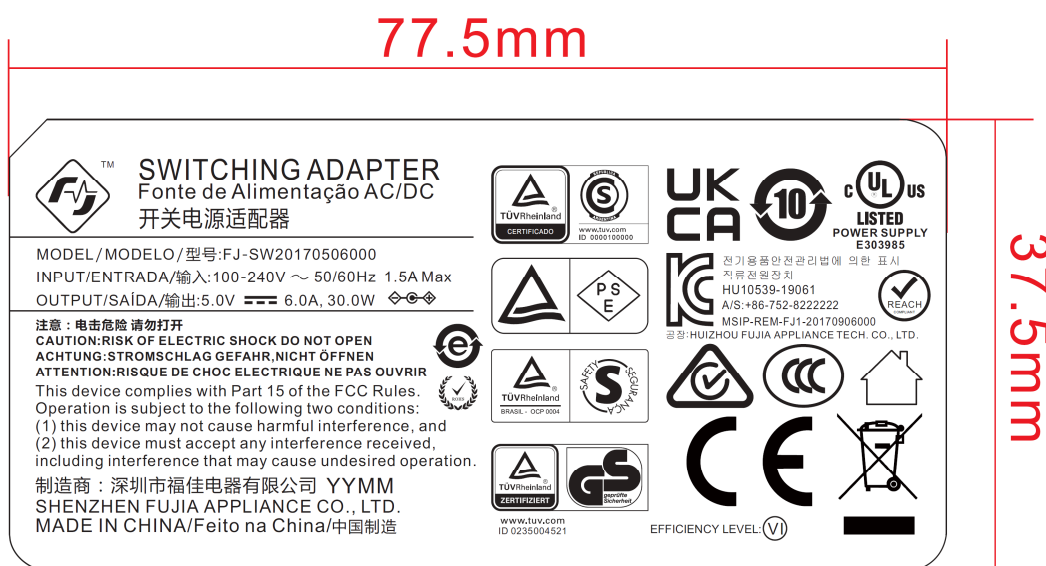

比例/Scale:2:1

电源适配器的《使用说明书》作为附件一并出厂销售，弃用《使用说明书》将有违反国家相关标准的风险。

注：客户下达订单时请提供该批次产品的“欧盟+英国进口商的名称及地址”“日本进口商名称”，韩国进口商的“售后服务电话”，以便体现在电源产品铭牌中。

注：铭牌上的YYMM为生产年、月，如2106代表2021年6月，生产年月随订单变化而变化，每一批都不一样，请找业务确认。

警示：
以上铭牌为贵公司指定，如由此产生不良后果，与福佳公司无关，敬请贵公司相关人员知悉，回签即确认，谢谢！

Caution:
The above label is designed by your company, it has nothing to do with Shenzhen Fujia Appliance Co, Ltd. If it leads to some bad results, we will consider it is confirmed if you sign by return, pls note. Thank you.

备注/Note:

1. 材料/Material：消银龙 100#（过光膜）/过网格/REACH/CA65
2. 印刷/Printing：黑底白字/ black ground White character
3. 尺寸/Size:(W)37.5mm+/-0.2mm (H) 77.5mm+/-0.2mm
4. 厚度/Thickness:0.15mm

注：
1.CE/UKCA/UL 标志，最低高度为5MM
2.“WEEE” 垃圾桶标志，最低高度为7MM
3.GS ID: 0235004521

PE 袋: 料号 : 780115022001002

150mm (开口方向)



使用说明书

制造商 : 以产品铭牌为准
网 址 : www.sz-fujia.com
产品名称 : 以产品铭牌为准
产品型号/规格 : 以产品铭牌为准

- 1.本产品为额定输出,不能超功率使用。
- 2.本产品仅适用于室内干燥环境中,距离周围物品的最小距离为10cm。
- 3.本产品请勿覆盖诸如报纸、桌布和窗帘等物品而妨碍通风散热。
- 4.本产品请勿放置裸露的火焰源或者高温物品,如点燃的蜡烛。
- 5.本产品不得遭受水滴或水溅,不得放置诸如花瓶一类的装满液体的物品。
- 6.请勿打开产品外壳以免发生电击伤害。
- 7.本产品不得与生活垃圾一起处理,须在认可的地方弃置,以便循环再造电器及电子产品。
- 8.本产品的电源插头(或器具插座)作为断开装置,插座应安装在设备附近且保持便于操作。

220mm

尺寸 : 150*220 (+5/-2mm) *0.033mm

印刷 : 单面印刷红色回收标志(加说明书内容) (打孔)

提示:电源适配器的《使用说明书》作为附件一并出厂销售,
弃用《使用说明书》将有违反国家相关标准的风险。

13 包装图示 PACKING

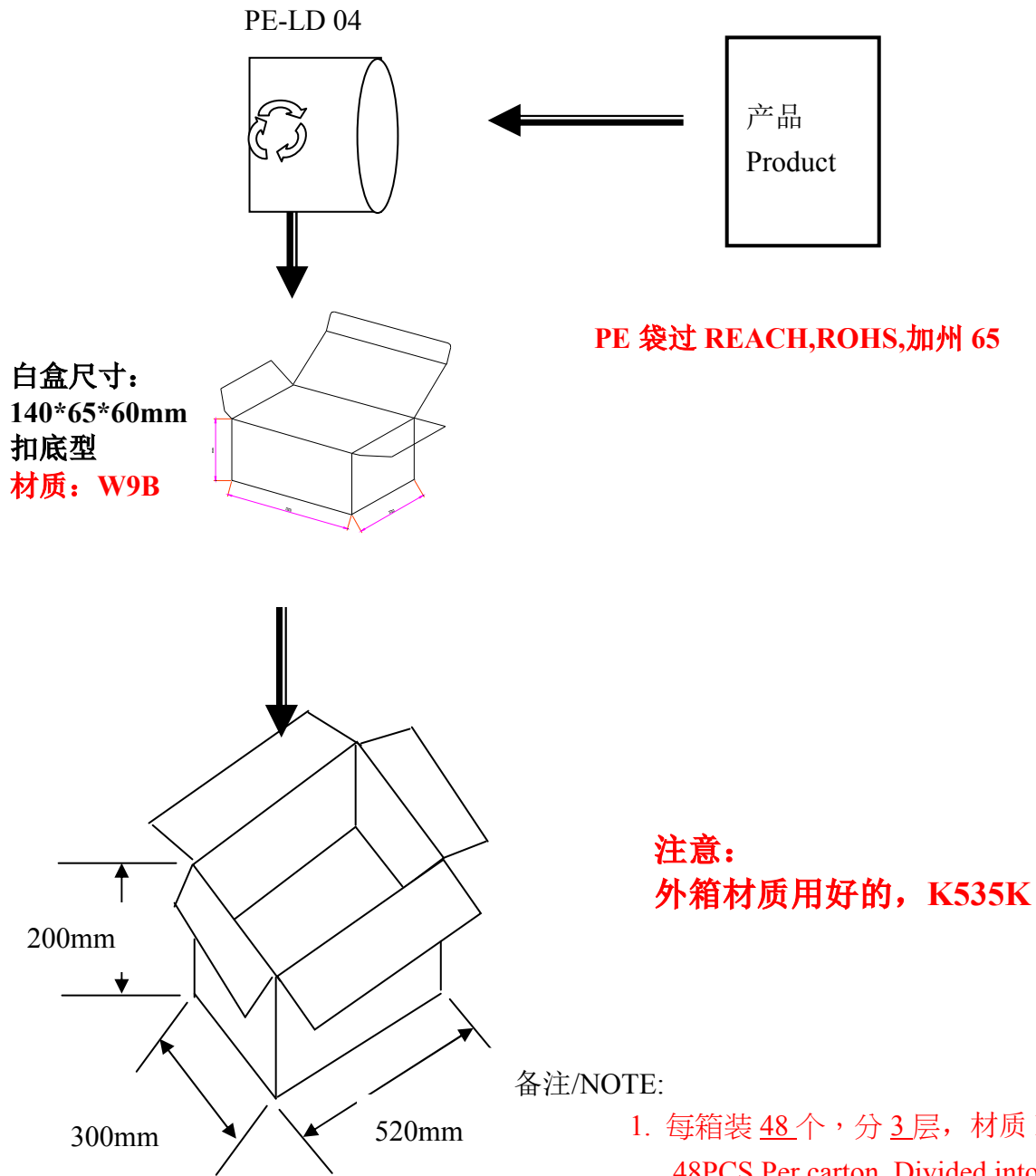

备注/NOTE:

- 每箱装 48 个，分 3 层，材质 K=K
48PCS Per carton, Divided into 3 floor.
Material K=K
- PE 袋尺寸：220X150MM 带环保标志。
PE bag size: 220X150MM , With the
environmental protection symbol.

安全手册/safety manual



Safety Manual

DE : Spezifikation

FR : Specification

ES : Especificacion

IT : Specificazioni

CN : 產品規格

SAFETY NOTES

DE : Spezifikation

FR : Specification

ES : Especificacion

IT : Specificazioni

CN : 產品規格

EN

UP

- ▶ DO NOT use the product in the overload condition.
- ▶ DO NOT Wet, incinerate, or disassemble the product.
- ▶ DO NOT crush, throw or shake the product.
- ▶ Unplug the product from wall outlet and disconnect it from your devices before cleaning or when not in use.
- ▶ Keep out of reach of children.
- ▶ Please use the original or certified cables.

◀ 1 ▶

DE

UP

- ▶ Verwenden Sie das Produkt NICHT im Überlast Zustand.
- ▶ Das Produkt NICHT nass machen, verbrennen oder zeneggen.
- ▶ Das Produkt NICHT zerdrücken werfen oder schütteln.
- ▶ Ziehen Sie das Produkt aus der Wandsteckdose und trennen Sie es von ihren Geräten, bevor Sie es reinigen oder wenn Sie es nicht benutzen.
- ▶ Darf nicht in die Hände von Kindern Gelangen.
- ▶ Verwenden Sie bitte das Original Kabel oder zertifizierte kabel.

◀ 2 ▶

FR

UP

- ▶ Veuillez NE PAS utiliser ce produit en cas de surcharge.
- ▶ Veuillez NE PAS mouiller, brûler et démonter le produit.
- ▶ Veuillez NE PAS écraser, jeter ou secouer le produit.
- ▶ Débranchez le produit de la prise murale et débranchez-le de votre appareil connecté avant de le nettoyer ou lorsqu'il n'est pas utilisé.
- ▶ Gardez hors de portée des enfants.
- ▶ Veuillez connecter les câbles d'origine ou certifiés à ce produit.

◀ 3 ▶

ES

UP

- ▶ Para evitar daños al producto y sus dispositivos, NO lo use en condiciones de sobrecarga.
- ▶ No moje, incinere ni desmonte el producto.
- ▶ No aplaste, arroje ni sacuda el producto
- ▶ Desenchufe el producto de la toma de corriente y desenchufe su dispositivo antes de limpiarlo o cuando no esté en uso.
- ▶ Mantenga este producto fuera del alcance de los niños.
- ▶ Utilice los cables originales o certificados

◀ 4 ▶

IT

- ▶ NON utilizzare il prodotto in condizioni di sovraccarico.
- ▶ NON bagnare, incenerire o disassemblare il prodotto.
- ▶ NON schiacciare, lanciare o scuotere il prodotto.
- ▶ Scollegare il prodotto dalla presa a muro e scollegarlo dai dispositivi prima di pulirlo o quando non viene utilizzato.
- ▶ Tenere fuori dalla portata dei bambini
- ▶ Utilizzare i cavi originali o certificate

CN

- ▶ 为避免损坏产品和设备,请勿在过载情况下使用该产品。
- ▶ 请不要打湿、焚烧以及拆解该产品。
- ▶ 请不要碾压、抛掷以及摇晃该产品。
- ▶ 在清洁之前或不使用时,请从墙壁插座上拔下本产品并断开其与设备的连接。
- ▶ 放在儿童接触不到的地方。
- ▶ 请使用原装或正规数据线连接本产品。

IMPORTANT WEEE INFORMATION



This symbol on the product(s) and / or accompanying documents indicates that, under the new Directive 2012/19/EU on waste electrical and electronic equipment (WEEE), product(s) used electrical and electronic equipment (WEEE) should not be mixed with general household waste. For proper treatment, recovery and recycling, please take this product(s) to designated collection points where it will be accepted free of charge.

Disposing of this product correctly will help save valuable resources and prevent any potential negative effects on human health and the environment, which could otherwise arise from inappropriate waste handling.

Please contact your local authority for further details of your nearest designated collection point.

Penalties may be applicable for incorrect disposal of this waste, in accordance with your national legislation.

For professional users in the European Union

If you wish to discard electrical and electronic equipment (EEE), please contact your dealer or supplier for further information.

For disposal in countries outside of the European Union

This symbol is only valid in the European Union (EU). If you wish to discard this product please contact your local authorities or dealer and ask for the correct method of disposal.



bridge
the gap

Contact Us

For more information about your UP board, software, accessories and peripherals, please visit www.up-community.org

If you have any questions, please contact us: info@up-board.org

安全手册制作要求如下:

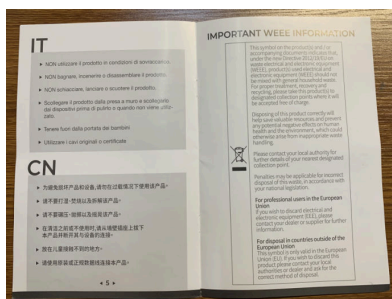
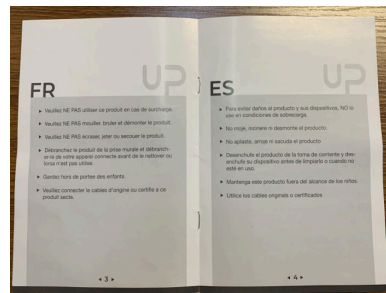
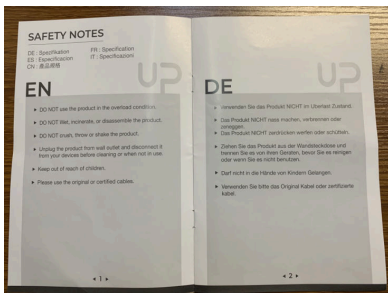
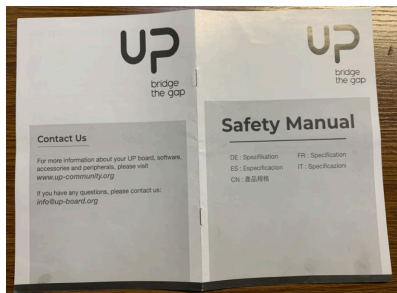

注: 钉钉对折, 效果如图所示

注: 1.展开尺寸: 长 210mm*宽 280mm

2.装钉合起来尺寸: 长 210mm*宽 140mm

3.安全手册对折两次, 放进样品上面. 参考如下图

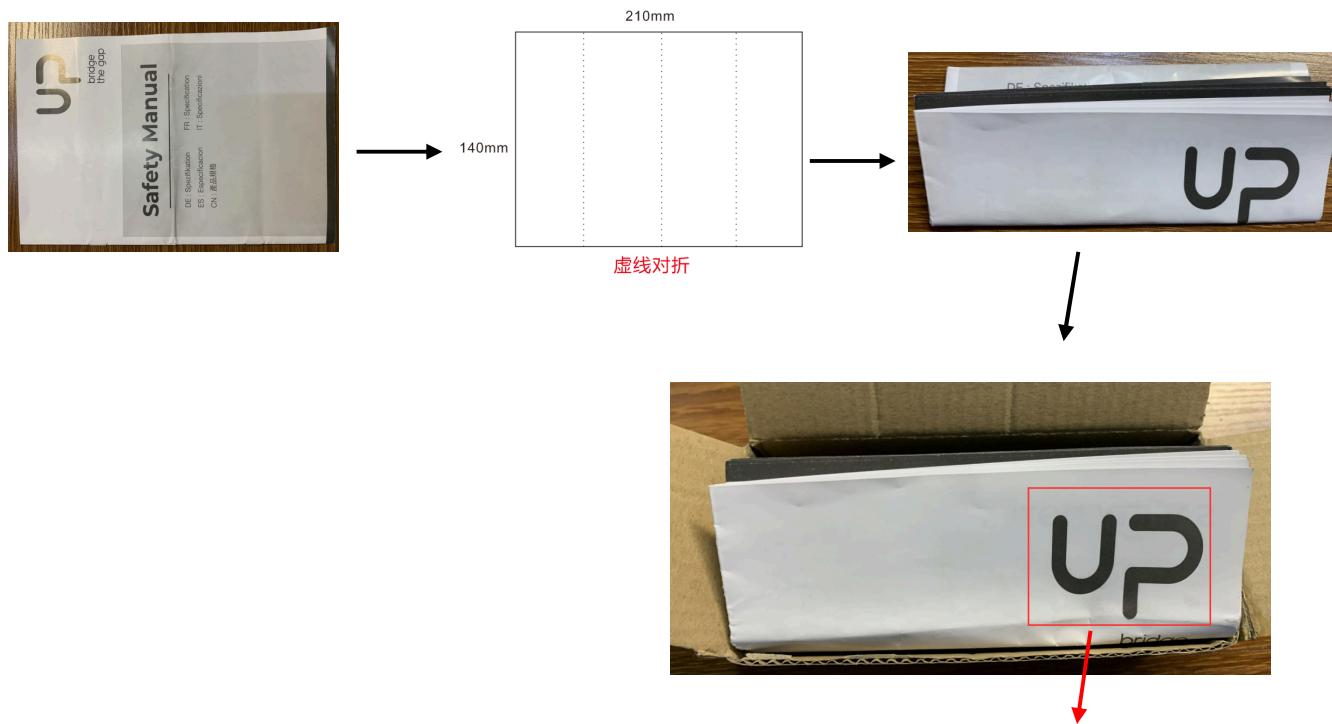

注: Logo 面朝上

白盒标贴:

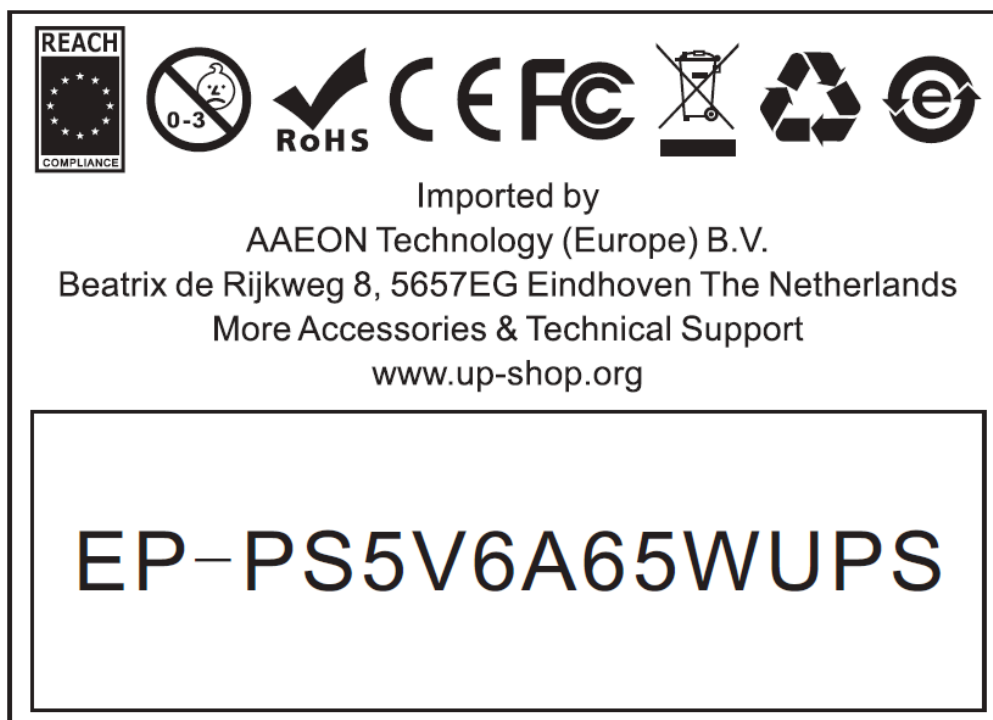

备注

- 1.尺寸/Size:长 63*宽 45mm
- 2.材质/Material: 铜版纸
- 3.印刷/Print: 白底黑字/white ground black character

白盒贴纸贴法如下图: (贴在白盒正面正中间位置)



1. 客户专门指定包装。
2. 要印外箱唛头，印正唛 2 面， 要印四个标志，外箱上要编箱号，（图 1，供参考）



图 1

实际参数内容如下：

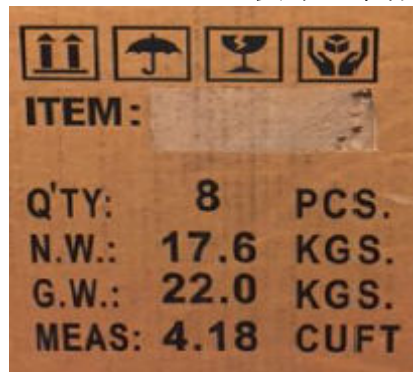
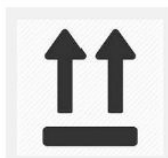

ITEM: EP-PS5V6A65WUPS

QTY: 48 PCS

N.W.: KG (请生产时用大头笔填写)

G.W.: KG (请生产时用大头笔填写)

P/O: PON1700336 (业务提供：随生产订单变化而变化)

Carton: (比如1/28 表示第一箱，如此类推，请生产时用大头笔填写)

MEAS: 52*30*20CM

Made in China

3. 包装密封，纸箱要用 K535K 材质，不能打钉子的纸箱如图。

can be stacked perfectly.

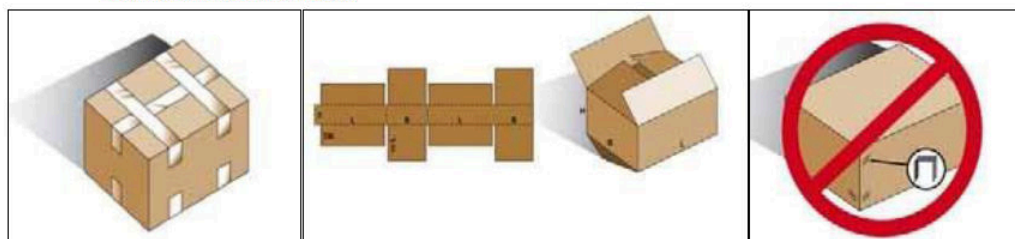

4. 要用纸卡板包装，长宽 1.8*2 米 货物总高度不能超过 1.6M 如图



14 样品测试报告SAPLES TEST REPORT

客户 Customer	F14AA0217	客户编号 Customer No	FJOS1808183	室温 Ambient temp	25℃					
产品型号 Model NO	2017	产品编号 Part No		日期 Date	9月3日					
输入电压/频率 Input volt/Freq	100-240Vac 50/60HZ	输出电压/电流 Output volt/Amp	5V 6A							
测试内容 Test content		1#样机/Sample NO:		2#样机/Sample NO:						
NO	测试项目 Test Item	测试标准 spec	115Vac	230Vac	判定 judge PASS or NG					
1	空载电压 Unload voltage	4.75-5.45V			PASS					
2	空载纹波与噪声 UnLoad ripple&noice	≤120mV P-P			PASS					
3	满载电压 Rated Load output Voltage	4.75-5.45V			PASS					
4	满载纹波与噪声 Rated load ripple&noice	≤120mV P-P			PASS					
5	额定输入电流 Rated input current	≤1500mA			PASS					
6	短路保护 Shortcircuit protection	No damage and auto recovered OK/NG			PASS					
7	过流保护 Over current protection	6.6-12A			PASS					
8	介电强度测试 Hi-Pot test	AC1.5KV 60S	<5mA	泄漏电流/Leakage current (mA) ; 绝缘击穿/insulation breakdown: ■OK □NG						
9	绝缘阻抗测试 Insulation resistance	DC500V 5S	>10MΩ	绝缘阻抗/insulation resistance (197 MΩ) ; 绝缘击穿/insulation breakdown: ■OK □NG						
10	输入/Input		输出/Output				能源之星/Energy star			
	电压 Voltage	功率 Pin(W)	负载% Load%	电压 Vout (V)	电流 Iout (A)	功率 Watt (W)	效率 EFF (%)	平均效率 average Eff (%)	能效标准 VI SPEC	空载功耗 Standby Power (W)
	115Vac		100%		6	0.000	#DIV/0!	#DIV/0!	平均效率 AVG EFF ≥85.07%	空载功耗 Standby Power <0.1W
			75%		4.5	0.000	#DIV/0!			
			50%		3	0.000	#DIV/0!			
			25%		1.5	0.000	#DIV/0!			
	230Vac		100%		6	0.000	#DIV/0!	#DIV/0!	平均效率 AVG EFF ≥85.07%	空载功耗 Standby Power <0.1W
			75%		4.5	0.000	#DIV/0!			
		50%		3	0.000	#DIV/0!				
		25%		1.5	0.000	#DIV/0!				
115Vac		10%			0.000	#DIV/0!	EFF (%)	≥69.64%	PASS	
230Vac		10%			0.000	#DIV/0!	EFF (%)		PASS	
11	100V/240V输入时满载开关机测试 Turn on/off test when rated load and input 100V/240Vac		10 times	正常开机 Normal turn on : ■OK □NG						PASS
12	115-240V 满载老化/Rated load burn-in test at 115V-240Vac		≥4 hours	无损坏No damage : ■OK □NG						PASS