

UPS-APL Board Quick Installation Guide

REVISION HISTORY

Revision	Date	Comments
A0.1	2016/09/01	Initial Version
A0.2	2016/11/03	
A0.3	2017/01/26	
A0.4	2017/04/07	

Table of Content

- 1. UPS-APL v1.0 Board Layout-4-
- 2. Connector References-5-
- 3. Connector Pin Assignments.....-6-

1. UPS-APL v1.0 Board Layout

TOP

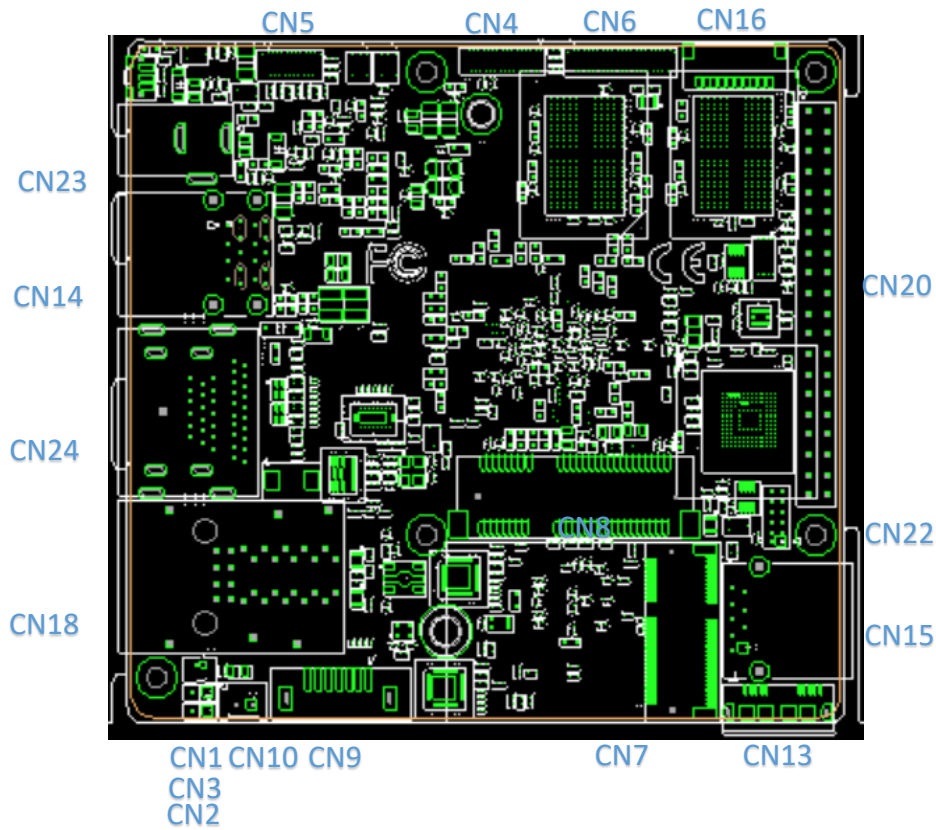

BOTTOM

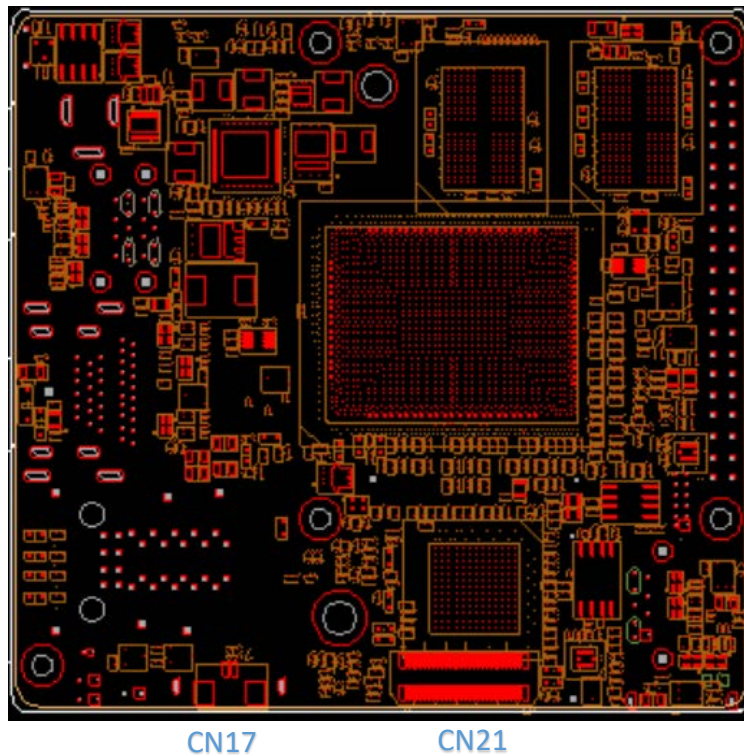

2. Connector References

Connector Index

Reference Designation	Functional Description	Connector Type
CN1	RTC	(TF)WAFER BOX.2P.180D(M).DIP.1.25mm.PINREX.712-71-02TW01
CN2	POWER BUTTON	(TF)PIN HEADER.2*1P.180D.(M).2.0mm.DIP
CN3	RESET	(TF)PIN HEADER.2*1P.180D.(M).2.0mm.DIP
CN4	CAMERA	(TF)FPC/FFC Conn..31P.90D(F).SMD.0.3mm.Dual Contact.Panasonic.AYF333135
CN5	CAMERA	(TF)FPC/FFC Conn.21P.90D(F).SMD.0.6mm.Hirose.FH35C-21S-0.3SHW(50)
CN6	eDP	(TF)FPC/FFC Conn.41P.90D(F).SMD.0.6mm.Hirose.FH35C-41S-0.3SHW(50)
CN7	M.2 E-KEY	(TF)M.2 Key-E Slot.75P.90D(F).SMD.Pitch 0.5mm.H=6.7mm.BLACK.FOXCONN.AS0BC21-S67BE-LH
CN8	mini Card	(TF)MiniCard SLOT.52P.90D.(F).SMD.FOXCONN.AS0B226-S68Q-7H
CN9	SATA	(TF)SATA CONNECTOR.7P.180D(M).SMT.TechBest.007-01-00757
CN10	SATA POWER	(TF)WAFER BOX.2P.180D(M).DIP.2.0mm.w/LOCK.PINREX.721-81-02TW00
CN13	USB3 OTG	(TF)Micro USB 3.0 Conn..10P.90D(M).SMD.B-type.ATTEND.209E-BE01
CN14	USB3 DUAL PORT	(TF)USB3.0 CONNECTOR.DUAL PORT.18P.90D(F).Contek.UDNFA199N-AY-00-A
CN15	USB3	(AOH)(TF).USB3.0 CONNECTOR.Single A Type.5405-X01-011-01.VENUS Series
CN16	USB panel	(TF)Wafer Box.10P.90D(M).SMD.1.0mm.CATCH.1204-700-10RM
CN17	FAN	(TF)WAFER.2P.180D(M).SMD.1.25mm.W/Cap.PINREX.712-73-02TWE0
CN18	LAN DUAL PORT	(TF)GIGA RJ45.28P.90D(F).W/TF&LED.DAUL PORT.DIP.UDE.RM3-169A9V1Q
CN20	HAT40	(TF)PIN HEADER.20*2P.180D(M).DIP.2.54mm.JVE.21N22564-40S20B-01G-5.5/3.3
CN21	EXHAT	(AOH)(TF)Board-Board Connector.60P.180D(M).SMD.Pitch=0.5mm.Header.Panasonic.AXK6S60547YG
CN22	CPLD and BIOS update	(TF)PIN HEADER.6*2P.180D(M).DIP.1.27mm.Astron.27-4121-

		206-1G-R
CN23	DC JACK	(TF)DC Power Jack.3P.90D(M).DIP.2.0mm.COXOC.416AEWTJ02004PA
CN24	HDMI + DP PORT	(TF)HDMI/DP combo Port conn..39P.90D(F).DIP.FOXCONN.3VD11203-HHJ0-4H

3. Connector Pin Assignments

CN1: RTC Battery

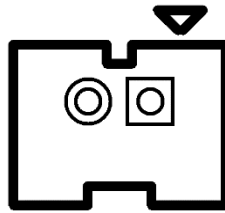

Pin	Signal Description	Pin	Signal Description
1	3.3V	2	GND

CN2: POWER BUTTON

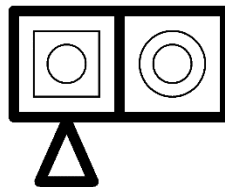

Pin	Signal Description	Pin	Signal Description
1	PWRBTN #	2	GND

CN3: RESET

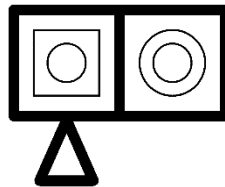

Pin	Signal Description	Pin	Signal Description
1	RESET #	2	GND

CN4: CAMERA

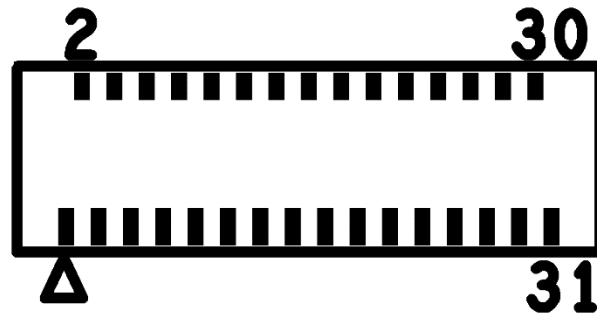

Pin	Signal Description	Pin	Signal Description	Pin	Signal Description
1	GND	2	RESET #	3	NC
4	I2C_DAT	5	I2C_CLK	6	GND
7	CLOCK	8	GND	9	data negative 0
10	data positive 0	11	GND	12	data negative 1
13	data positive 1	14	GND	15	clock negative
16	clock positive	17	GND	18	data negative 2
19	data positive 2	20	GND	21	data negative 3
22	data positive 3	23	GND	24	2.8V
25	GND	26	1.2V	27	1.8V
28	GND	29	2.8V	30	2.8V
31	GND	32		33	

CN5: CAMERA

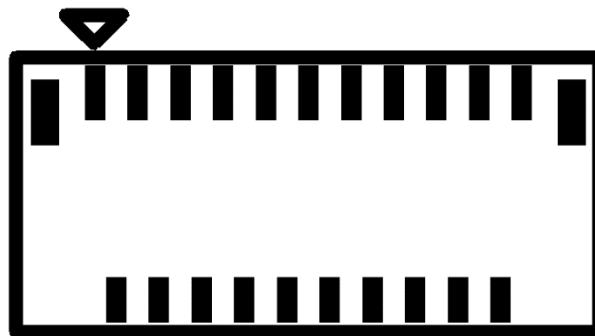

Pin	Signal Description	Pin	Signal Description	Pin	Signal Description
1	GND	2	data negative 1	3	data positive 1
4	GND	5	clock negative	6	clock positive
7	GND	8	data negative 0	9	data positive 0
10	GND	11	1.2V	12	1.8V
13	GND	14	CLOCK	15	GND
16	I2C_CLK	17	I2C_DAT	18	RESET #
19	RESET #	20	2.8V	21	GND

CN6: eDP

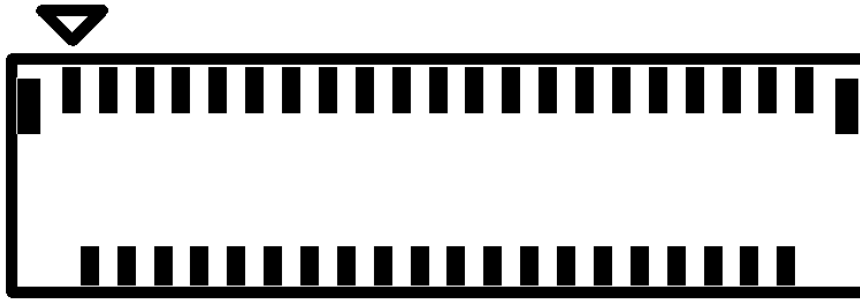

Pin	Signal Description	Pin	Signal Description	Pin	Signal Description
1	NC	2	NC	3	GND
4	NC	5	NC	6	GND
7	NC	8	NC	9	GND
10	NC	11	NC	12	GND
13	NC	14	NC	15	GND
16	data positive 0	17	data negative 0	18	GND
19	data positive 1	20	data negative 1	21	GND
22	data positive 2	23	data negative 2	24	GND
25	data positive 3	26	data negative 3	27	GND
28	AUX positive	29	AUX negative	30	GND
31	Hot Plug Detect	32	Back Light Control	33	VDD Enable
34	Back Light Enable	35	I2C_CLK	36	I2C_DAT
37	3.3V	38	3.3V	39	3.3V
40	3.3V	41	3.3V		

CN7: M.2 E-KEY

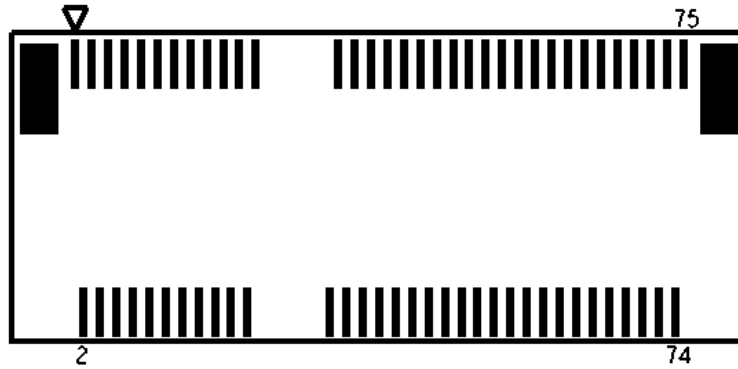

Pin	Signal Description	Pin	Signal Description	Pin	Signal Description
1	GND	2	3.3V	3	USB_D+
4	3.3V	5	USB_D+	6	NC
7	GND	8	NC	9	NC
10	NC	11	NC	12	NC
13	NC	14	NC	15	NC
16	NC	17	NC	18	GND
19	NC	20	NC	21	NC
22	UART_RXD	23	NC	24	N/A
25	N/A	26	N/A	27	N/A
28	N/A	29	N/A	30	N/A
31	N/A	32	UART0_TXD	33	GND
34	UART0_CTS	35	PCIE_C_TXP3	36	UART0_RTS
37	PCIE_C_TXN3	38	NC	39	GND
40	NC	41	PCIE_RXP3	42	NC
43	PCIE_RXN3	44	NC	45	GND
46	NC	47	CLK_PCIE_M2_P	48	NC
49	CLK_PCIE_M2_N	50	Suspend Clock	51	GND
52	RESET #	53	PCIE_M2_CLKREQ#	54	Bluetooth Enable
55	WAKE #	56	Wi-Fi Enable	57	GND
58	SMBus_DAT	59	NC	60	SMBus_CLK
61	NC	62	SMBus_Alert	63	GND
64	NC	65	NC	66	NC
67	NC	68	NC	69	GND
70	NC	71	NC	72	3.3V
73	NC	74	3.3V	75	GND

CN8: mini Card

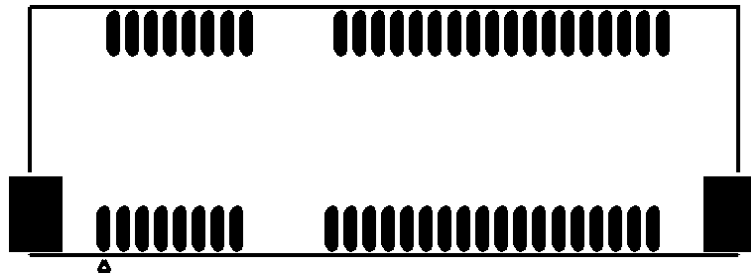

Pin	Signal Description	Pin	Signal Description	Pin	Signal Description
1	WAKE #	2	3.3V	3	NC
4	GND	5	INT_SERIRQ	6	1.5V
7	PCIE_MINI_CLKREQ#	8	NC	9	GND
10	NC	11	CLK_PCIE_MINI_N	12	NC
13	CLK_PCIE_MINI_P	14	NC	15	GND
16	NC	17	NC	18	GND
19	NC	20	3G Enable	21	GND
22	RESET #	23	PERn0_mSATA_R+	24	3.3V
25	PERp0_mSATA_R-	26	GND	27	GND
28	1.5V	29	GND	30	I2C_CLK
31	PETn0_mSATA_T-	32	I2C_DAT	33	PETp0_mSATA_T+
34	GND	35	GND	36	USB_D-
37	GND	38	USB_D+	39	3.3V
40	GND	41	3.3V	42	NC
43	mSATA_PCl_e_SEL_C	44	NC	45	NC
46	NC	47	NC	48	1.5V
49	NC	50	GND	51	NC
52	3.3V				

CN9: SATA

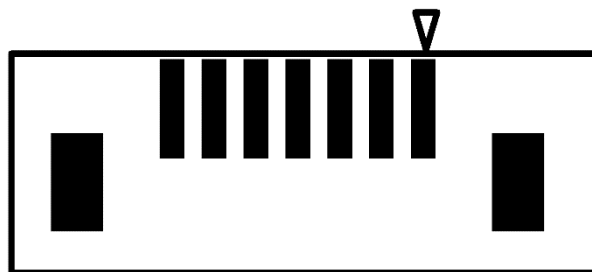

Pin	Signal Description	Pin	Signal Description	Pin	Signal Description
1	GND	2	TX+	3	TX-
4	GND	5	RX-	6	RX+
7	GND				

CN10: SATA POWER

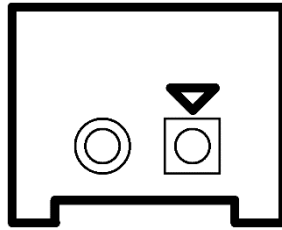

Pin	Signal Description	Pin	Signal Description
1	5V	2	GND

CN13: USB3 OTG

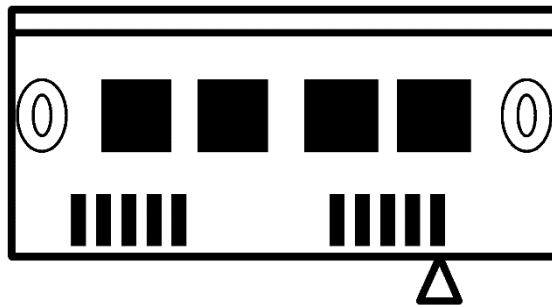

Pin	Signal Description	Pin	Signal Description	Pin	Signal Description
1	5V	2	USB2_D-	3	USB2_D+
4	ID	5	GND	6	USB_RX-
7	RSB3_RX+	8	GND	9	USB3_TX-
10	USB3_TX+				

CN14: USB DUAL PORT

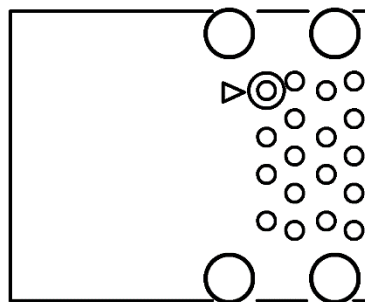

Pin	Signal Description	Pin	Signal Description	Pin	Signal Description
1	5V	2	USB2_D1-	3	USB2_D1+
4	GND	5	USB3_RX1-	6	USB3_RX1+
7	GND	8	USB3_TX1-	9	USB3_TX1+
10	5V	11	USB2_D2-	12	USB2_D2+
13	GND	14	USB3_RX2-	15	USB3_RX2+
16	GND	17	USB3_TX2-	18	USB3_TX2+

CN15: USB3

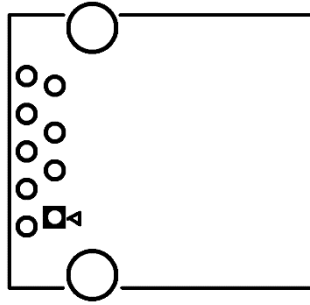

Pin	Signal Description	Pin	Signal Description	Pin	Signal Description
1	5V	2	USB2_D-	3	USB2_D+
4	GND	5	USB3_RX-	6	USB3_RX+
7	GND	8	USB3_TX-	9	USB3_TX+

CN16: USB PANEL

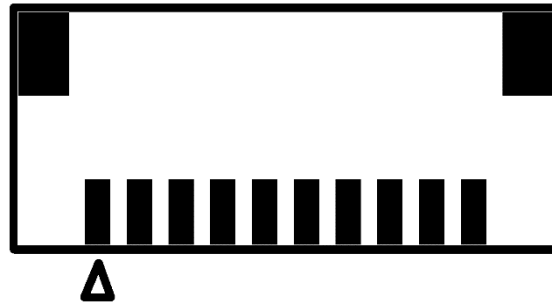

Pin	Signal Description	Pin	Signal Description	Pin	Signal Description
1	5V	2	USB2_D1-	3	USB2_D1+
4	GND	5	5V	6	USB2_D2-
7	USB2_D2+	8	GND	9	UART_RX
10	UART_TX				

CN17: FAN

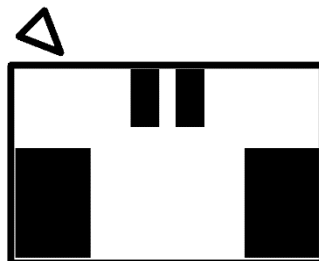

Pin	Signal Description	Pin	Signal Description
1	5V	2	GND

CN18: LAN DUAL PORT

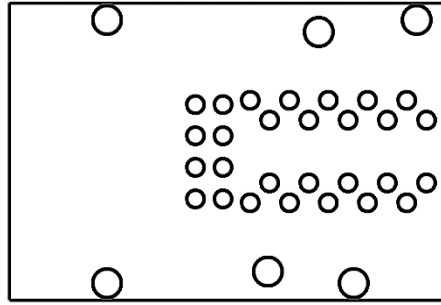

Pin	Signal Description	Pin	Signal Description	Pin	Signal Description
R1A	LAN1_MDI0+	R2A	LAN1_MDI0-	R3A	LAN1_MDI1+
R4A	LAN1_MDI1-	R5A	LAN1_MDI2+	R6A	LAN1_MDI2-
R7A	LAN1_MDI3+	R8A	LAN1_MDI3-	R9A	GND
R10A	GND	L1A	LAN1_ACTLED-	L2A	LAN1_ACTLED+
L3A	LAN1_LINK1000#	L4A	LAN1_LINK100#	R1B	LAN2_MDI0+
R2B	LAN2_MDI0-	R3B	LAN2_MDI1+	R4B	LAN2_MDI1-
R5B	LAN2_MDI2+	R6B	LAN2_MDI2-	R7B	LAN2_MDI3+
R8B	LAN2_MDI3-	R9B	GND	R10B	GND
L1B	LAN2_ACTLED-	L2B	LAN2_ACTLED+	L3B	LAN2_LINK1000#
L4B	LAN2_LINK100#				

CN20: HAT40

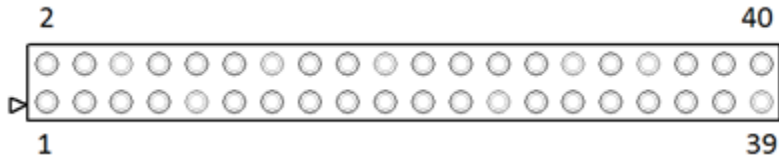

Pin	Signal Description	Pin	Signal Description	Pin	Signal Description
1	3.3V	2	5V	3	I2C1_DAT
4	5V	5	I2C1_CLK	6	GND
7	ANALOG_DATA1	8	UART_TX	9	GND
10	UART_RX	11	ANALOG_DATA2	12	I2S_BCLK
13	ANALOG_DATA3	14	GND	15	ANALOG_DATA4
16	SPI1_CS1	17	3.3V	18	SPI1_RX
19	SPI0_TX	20	GND	21	SPI0_RX
22	SPI1_TX	23	SPI0_CLK	24	SPI0_CS0
25	GND	26	SPI0_CS1	27	I2C0_DAT
28	I2C0_CLK	29	GPIO	30	GND
31	SPI1_CLK	32	PWM0	33	PWM1
34	GND	35	I2S_WS_SYNC	36	UART_CTS
37	SPI1_CS0	38	I2S_SDI	39	GND
40	I2S_SDO				

CN21: EXHAT

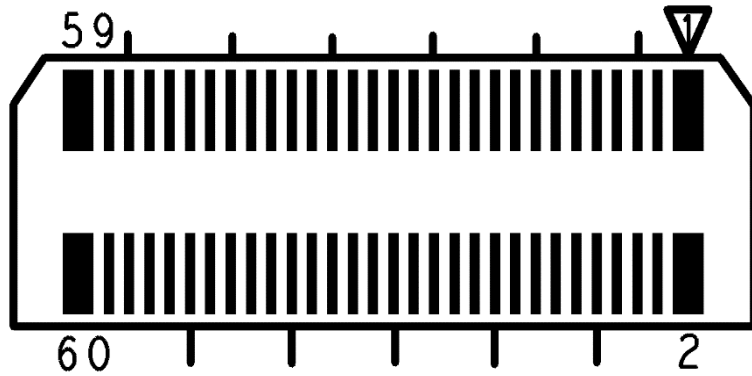

Pin	Signal Description	Pin	Signal Description	Pin	Signal Description
1	LVDS0-	2	LVDS1-	3	LVDS0+
4	LVDS1+	5	GND	6	GND
7	LVDS2-	8	LVDS3-	9	LVDS2+
10	LVDS3+	11	GND	12	GND
13	LVDS4-	14	LVDS5-	15	LVDS4+
16	LVDS5+	17	GND	18	GND
19	LVDS6-	20	LVDS7-	21	LVDS6+
22	LVDS7+	23	GND	24	GND
25	PLL_IN-	26	PLL1_OUT-	27	PLL1_IN+
28	PLL1_OUT+	29	GND	30	GND
31	INT_SERIRQ_R	32	LPC_R_CLKOUT0	33	LPC_CLKRU_N
34	GND	35	GND	36	LPC_R_AD3
37	SIO_SPI_1_TXD	38	LPC_R_AD2	39	SIO_SPI_1_RXD
40	LPC_R_AD1	41	SIO_SPI_1_FS0	42	LPC_R_AD0
43	SIO_SPI_1_FS1	44	GND	45	SIO_SPI_1_CLK
46	LPC_FRAME_R	47	GND	48	GND
49	I2C_SCL3_3V3	50	AVS_DMIC_CLK_A1	51	I2C_SDA3_3V3
52	AVS_DMIC_CLK_B1	53	GND	54	AVS_DMIC_CLK_AB2
55	I2C_SCL2_3V3	56	GND	57	I2C_SDA2_3V3
58	AVS_DMIC_DATA_1	59	GND	60	AVS_DMIC_DATA_2

CN22: CPLD and BIOS update

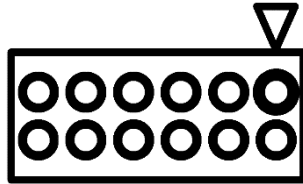

Pin	Signal Description	Pin	Signal Description	Pin	Signal Description
1	JTAG_TCK	2	GND	3	JTAG_TDO
4	1.8V	5	JTAG_TMS	6	SPI_CS
7	SPI_CLK	8	SPI_MISO	9	JTAG_TDI
10	GND	11	SPI_MOSI	12	SPI_HOLD

CN23: DC JACK

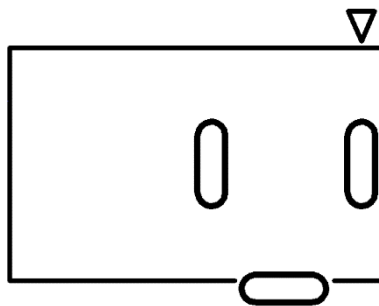

Pin	Signal Description	Pin	Signal Description	Pin	Signal Description
1	5V	2	GND	3	GND

CN24: HDMI+DP PORT

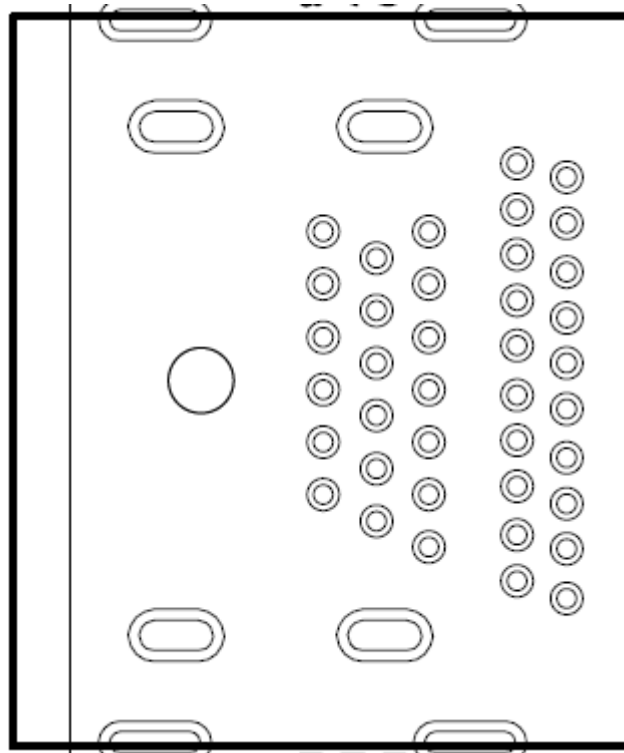

Pin	Signal Description	Pin	Signal Description	Pin	Signal Description
P1	DDI0_TXP_DP_0	P2	GND	P3	DDI0_TXN_DP_0
P4	DDI0_TXP_DP_1	P5	GND	P6	DDI0_TXN_DP_1
P7	DDI0_TXP_DP_2	P8	GND	P9	DDI0_TXN_DP_2
P10	PORT0_CLK+	P11	GND	P12	PORT0_CLK-
P13	CONFIG1	P14	CONFIG2	P15	DP_AUX_P
P16	GND	P17	DP_AUX_N	P18	DDI0_TYPE_C_HPD
P19	GND	P20	3.3V	P21	DDI1_TXP_HDMI_0
P22	GND	P23	DDI1_TXN_HDMI_0	P24	DDI1_TXP_HDMI_1
P25	GND	P26	DDI1_TXN_HDMI_1	P27	DDI1_TXP_HDMI_2
P28	GND	P29	DDI1_TXN_HDMI_2	P30	DDI1_CLK+_HDMI
P31	GND	P32	DDI1_CLK-_HDMI	P33	HDMI1_CEC_D
P34	NC	P35	DDC_CLK	P36	DDC_DATA
P37	GND	P38	5V		DDI1_TYPE_C_HPD